

Corner Castings.....	1-3
Stoughton.....	1-3
Great Dane .....	1-3
Hyundai.....	1-4
Lufkin .....	1-5
Monon .....	1-5
Pines .....	1-5
Strick .....	1-5
Trailmobile.....	1-6
Utility .....	1-6
Wabash.....	1-6
Corner Protectors .....	1-7
Stoughton.....	1-7
Great Dane .....	1-7
Pines .....	1-8
Strick .....	1-8
Corner Panels.....	1-9
Stoughton.....	1-9
Dorsey.....	1-11
Fruehauf.....	1-11
Great Dane .....	1-12
Hyundai.....	1-13
Kentucky .....	1-14
Lufkin .....	1-15
Manac .....	1-15
Monon .....	1-15
Pines .....	1-16
Strick .....	1-17
Strick.....	1-18

Trailmobile..... 1-19

Utility ..... 1-20

Vanguard Trailer..... 1-20

Wabash ..... 1-20

Corner LIners..... 1-21

    Stoughton..... 1-21

    Frehauf..... 1-23

    Hyundai..... 1-23

    Strick ..... 1-24

    Trailmobile..... 1-24

Corner Posts..... 1-25

    Stoughton..... 1-25

    Great Dane ..... 1-25

    Monon ..... 1-25

    Pines ..... 1-26

    Trailmobile..... 1-26

    Utility ..... 1-27

    Wabash ..... 1-28

Front Wall Posts ..... 1-29

    Stoughton..... 1-29

    Great Dane ..... 1-31

    Manac ..... 1-31

    Utility ..... 1-31

    Lufkin ..... 1-31

    Trailmobile..... 1-31

    Wabash ..... 1-31

Nose Rails ..... 1-32

    Stoughton..... 1-32

    Dorsey..... 1-33

    Fruehauf..... 1-33

    Great Dane ..... 1-34

    Hyundai..... 1-35

    Trailmobile..... 1-36

    Utility ..... 1-37

    Vanguard Trailers..... 1-38

    Wabash ..... 1-38

Front Wall Covers..... 1-40

    Stoughton..... 1-40

Front – Miscellaneous ..... 1-41

    Stoughton..... 1-41

## CORNER CASTINGS

Stoughton

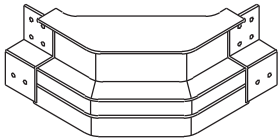

Stoughton Number	Model
* 04 09816 000 00	CONTAINER
04 12835 000 00	AV (shown)

04 12835 000 00 originally replaced 04 09728 000 00

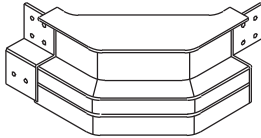

ROADSIDE

Stoughton Number	Model
04 12834 100 00	EV & FV

FRP

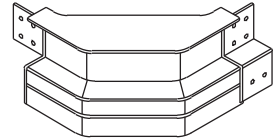

CURBSIDE

Stoughton Number	Model
04 12834 200 00	EV & FV

FRP

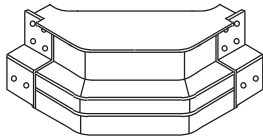

Stoughton Number	Model
* 04 13853 000 00	PDCW

J.B. Hunt only

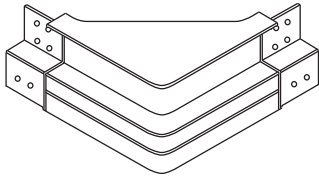

Stoughton Number	Model
04 14908 000 00	PV

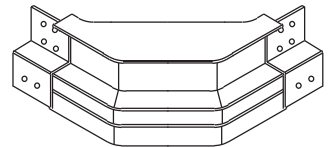

Stoughton Number	Model
04 18306 000 00	PVW

Replaces 04 16546 000 00



ALUMINUM CORNER CAP

Stoughton Number	Model
04 19507 000 00	DVW-28 (UPS)

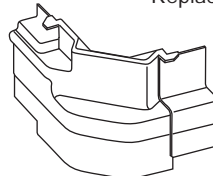

CORNER CASTING

Stoughton Number	Model
04 20624 100 00	ZPVW*
04 20624 200 00	ZPVW*

\* 100 = Roadside, 200 = Curbside

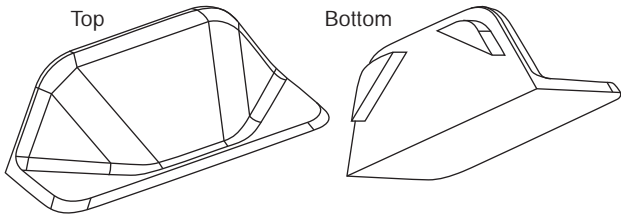

Top

Bottom

RUB RAIL CAP, ALUM T6

Stoughton Number
04 21987 000 00

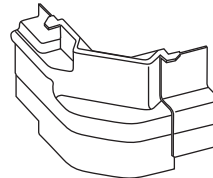

CORNER CASTING

Stoughton Number	Model
04 22044 100 00	ZGPPVW*
04 22044 200 00	ZGPPVW*

\* 100 = Roadside, 200 = Curbside

## Great Dane

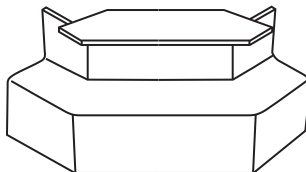

CORNER CAP, CAST ALUM

Stoughton Number
GD#69102183

\* Refers to Container

## CORNER CASTINGS

Hyundai

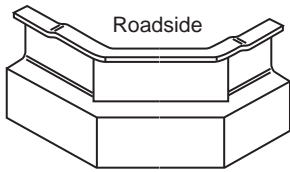

Roadside

CORNER CASTING, RS

Stoughton Number

HY#1000-4167

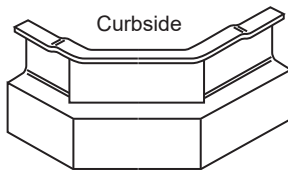

Curbside

CORNER CASTING, CS

Stoughton Number

HY#1000-4168

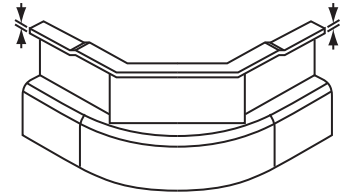

CORNER CAP, ALUM, LH

Stoughton Number

HY#1001-2219

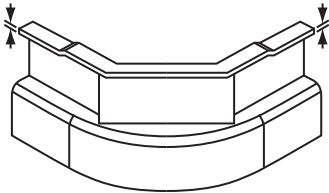

CORNER CAP, ALUM, RH

Stoughton Number

HY#1001-2220

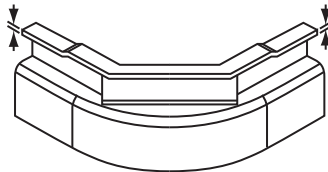

CORNER CAP, ALUM, LH

Stoughton Number

HY#1001-3434

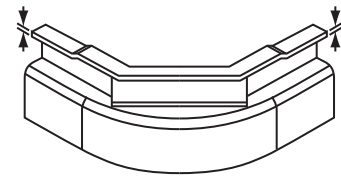

CORNER CAP, ALUM, RH

Stoughton Number

HY#1001-3435

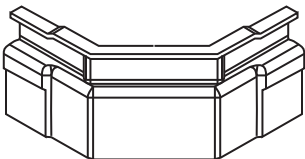

CORNER CAP

Stoughton Number

HY#1001-4978

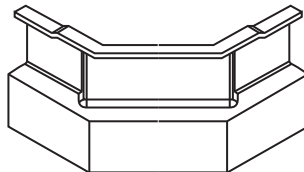

CORNER CAP

Stoughton Number

HY#1001-5378

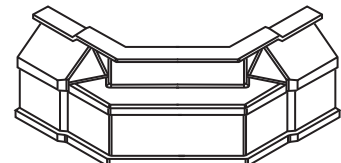

CORNER CAP, ALUM

Stoughton Number

HY#1001-5416

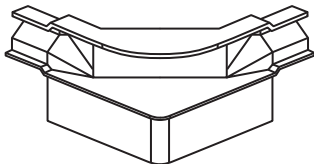

CORNER CAP, ALUM

Stoughton Number

HY#1001-6167

## CORNER CASTINGS

Lufkin



**CORNER CAP**  
**Stoughton Number**  
**LUF-60113**

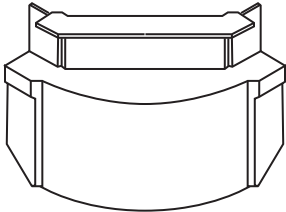

**CORNER CAP**  
**Stoughton Number**  
**LUF-65278**

Monon

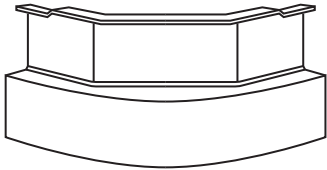

**CORNER CAP, ALUM**  
**Stoughton Number**  
**MON-AI042138**

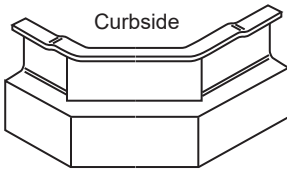

**CORNER CAP, CS, A101090-2**  
**Stoughton Number**  
**MON-V02-197R**

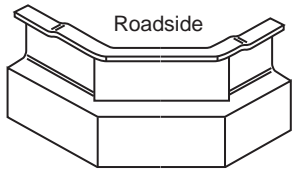

**CORNER CAP, RS, A101090-1**  
**Stoughton Number**  
**MON-V02-198L**

Pines

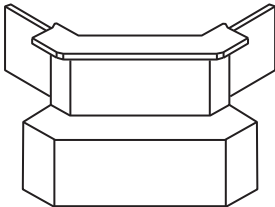

**CORNER CAP, PINES**  
**Stoughton Number**  
**PINE CC11100**

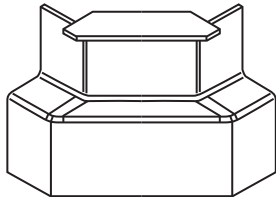

**CORNER CAP**  
**Stoughton Number**  
**PINE CCB7177**

Strick

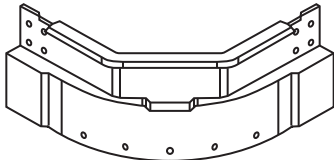

**CORNER CAP, ALUM**  
**Stoughton Number**  
**STR#GA65D0030100**

## CORNER CASTINGS

### Trailmobile

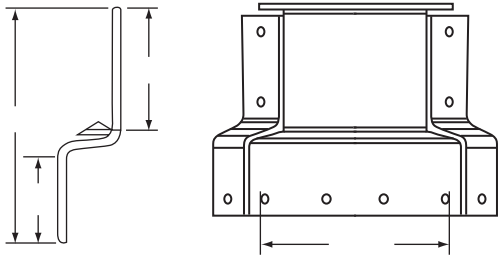

CORNER CASTING, ALUM

Stoughton Number
TM7511-A1-05

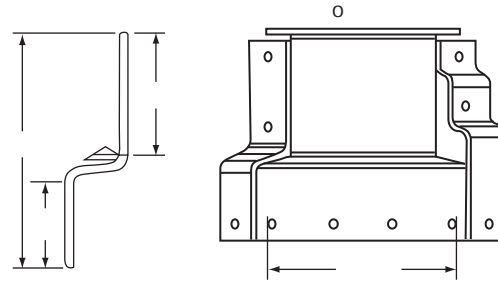

CORNER CASTING, ALUM

Stoughton Number
TM7511-A1-06L

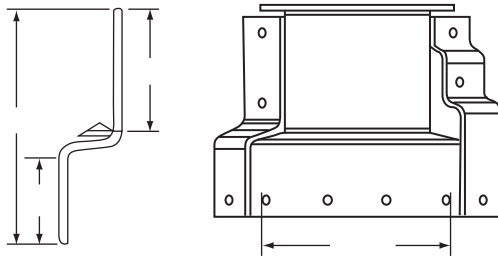

CORNER CASTING, ALUM

Stoughton Number
TM7511-A1-06R

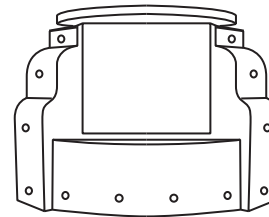

CORNER CASTING, ALUM

Stoughton Number
TM7511-A1-08

### Utility

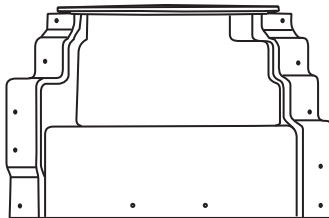

CORNER CASTING, CS

Stoughton Number
UT-01-1550-0-32

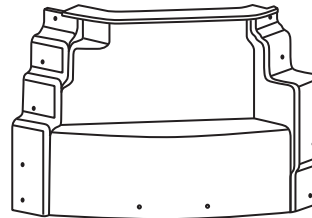

CORNER CASTING, RS

Stoughton Number
UT-01-1550-0-33

### Wabash

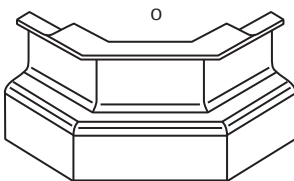

CORNER CAP

Stoughton Number
WAB-04300002

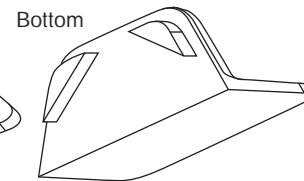
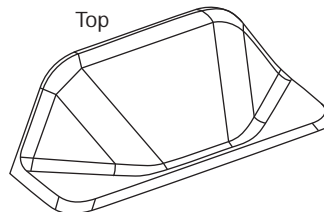

END CAP

Stoughton Number
WAB-04300004

## CORNER PROTECTORS

Stoughton

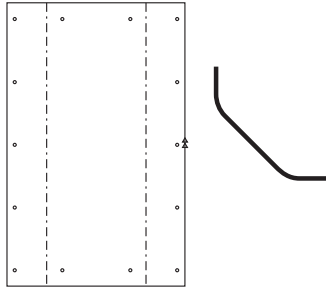

**SHEET/POST CORNER PROTECTOR**

Stoughton Number
01 18090 000 00

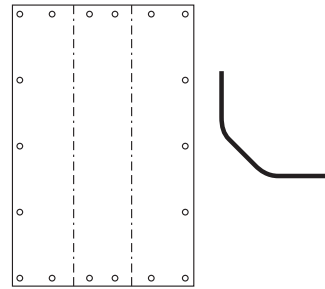

**Z-PLATE CORNER PROTECTOR**

Stoughton Number
01 22009 000 00

## Great Dane

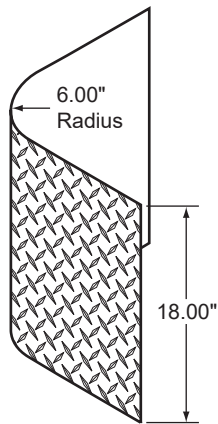

**6" CORNER PROTECTOR**

Stoughton Number
GD#40701201

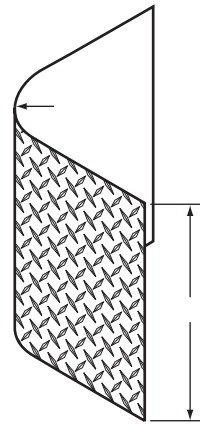

**6" CORNER PROTECTOR**

Stoughton Number
GD#40701227

**CORNER PROTECTORS**

**Pines**

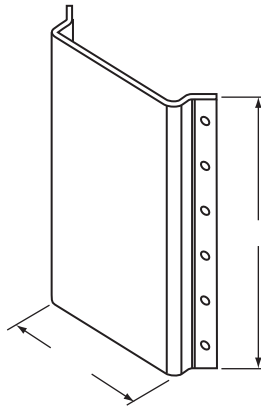

**CORNER PROTECTOR**

Stoughton Number
<b>PINE AMEB6465</b>

**Strick**

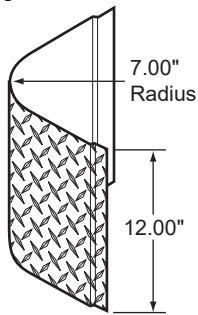

**7.25" CORNER PROTECTOR**

Stoughton Number
<b>STR#22476</b>

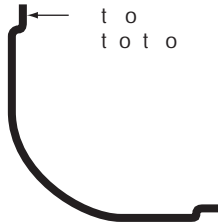

**CORNER PROTECTOR, MILL 7"**

Stoughton Number
<b>STR#28761</b>

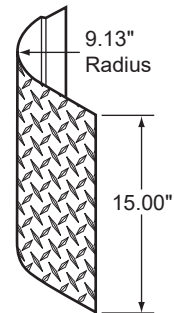

**9.125" CORNER PROTECTOR**

Stoughton Number
<b>STRAA59B10270100</b>



## CORNER PANELS Stoughton

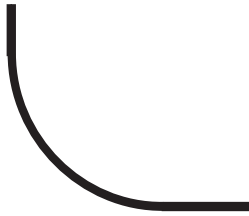

### RADIUS CORNER

Stoughton Number	Length	Material
01 04642 XXX 01	104"	.063 Aluminum – Prepainted White

Replaces 01 07739 000 00

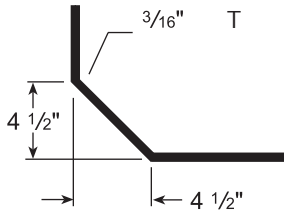

### BEVEL CORNER

Stoughton Number	Length	Material
01 08581 XXX 01	110 1/4"	.063 Aluminum – Prepainted White
01 08581 XXX 05	110 1/4"	.026 Galavan – Prepainted White
01 08637 XXX 00	108 1/2"	.036 Stainless Steel – Mirror
01 08637 XXX 01	108 1/2"	.036 Stainless Steel – Brush

All dimensions same except length

01 08581 XXX 01 replaces 01 09169 000 00

01 08581 XXX 05 replaces 01 10038 000 00

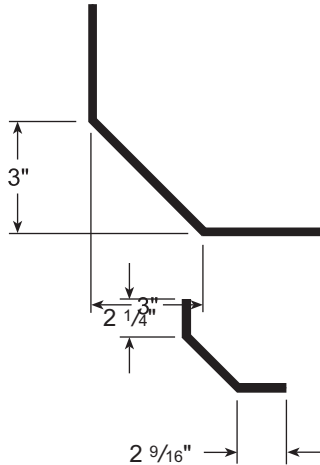

Stoughton Number	Length	Material
01 08808 XXX 00	89 3/4"	Aluminum

### BEVEL CORNER – CONTAINER

Stoughton Number	Length	Material
01 09849 XXX 00	101 1/2"	.063 Aluminum – Prepainted White

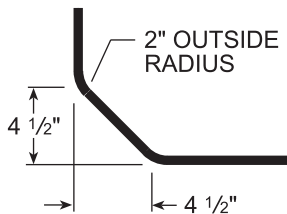

### BEVI-ROUND CORNER

Stoughton Number	Length	Material
01 12994 XXX 00	107"	.063 Aluminum – Prepainted White
01 12994 XXX 01	107"	.050 Aluminum – Prepainted Black
01 12994 XXX 04	107"	.036 Stainless Steel – Mirror
01 12994 XXX 05	107"	.026 Galavan – Prepainted White

01 12994 XXX 00 replaces 01 09919 000 00, 01 12954 000 00, 01 13260 000 00, 01 13311 000 00, 01 13465 000 00, 01 14998 000 00, and 01 16121 000 00

Other colors may be available. Please call with needs.

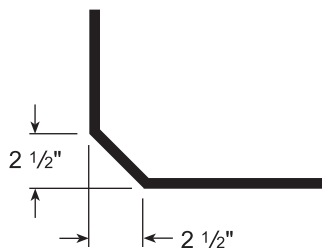

### BEVEL CORNER PANEL

Stoughton Number	Length	Material
01 13667 007 00	104 7/8"	.063 Aluminum – Prepainted White

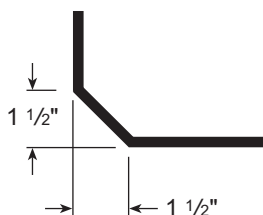

### BEVEL CORNER PANEL

Stoughton Number	Length	Material
01 14409 000 00	108 7/8"	Aluminum

## CORNER PANELS

Stoughton

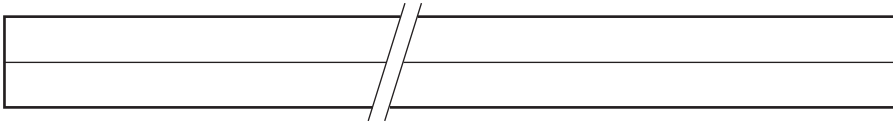

CORNER RADIUS, UNPUNCHED, BLUE

Stoughton Number
01 18760 X07 06

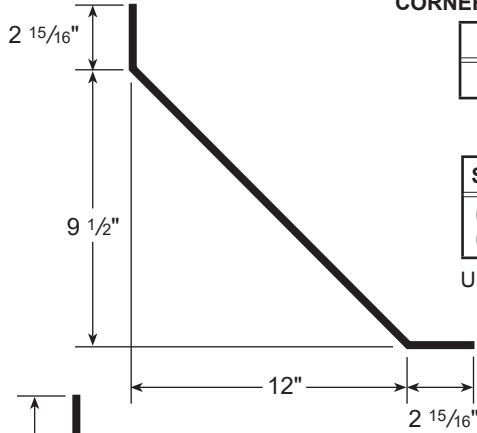

Stoughton Number	Length	Material	Remarks
01 19642 100 00	101"	.125 Mill Finish Aluminum	Roadside
01 19642 200 00	101"	.125 Mill Finish Aluminum	Curbside

UPS specification

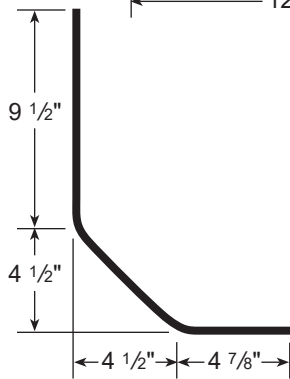

Stoughton Number	Length	Material	Remarks
01 20165 100 00	101 1/2"	.050 Aluminum	Roadside
01 20165 200 00	101 1/2"	.050 Aluminum	Curbside
01 20165 XXX 00	101 1/2"	.050 Aluminum	Unpunched

Fed Ex Ground specification

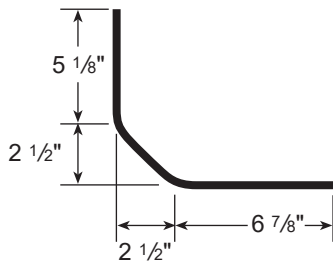

Z-PLATE

Stoughton Number	Length	Material	Remarks
01 20838 106 00	104 7/8"	.125 Mill Finish Stainless Steel	Roadside
01 20838 108 00	105.62"	.125 Mill Finish Stainless Steel	Roadside
01 20838 206 00	104 7/8"	.125 Mill Finish Stainless Steel	Curbside
01 20838 208 00	105.62"	.125 Mill Finish Stainless Steel	Curbside

Z-G-PLATE

Stoughton Number	Length	Material	Remarks
01 22583 106 00	104 7/8"	.125 Mill Finish Stainless Steel	Roadside
01 22583 206 00	104 7/8"	.125 Mill Finish Stainless Steel	Curbside

BEVEL CORNER PANEL – PLATE TRAILER

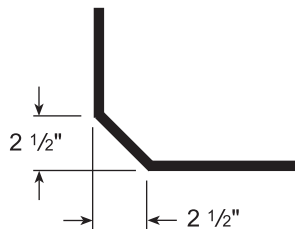

Stoughton Number	Length	Material
02 16671 109 12	109 1/8"	Mill Finish
04 13847 109 88	109 7/8"	Extruded Aluminum – Prepainted White

BEVEL CORNER PANEL – J.B. HUNT CONTAINER

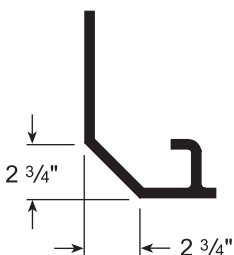

Stoughton Number	Length	Material	Remarks
04 14279 109 12	109 1/8"	Extruded Aluminum	White

Replaces 01 13951 100 00 and 01 13951 200 00

## CORNER PANELS

Dorsey

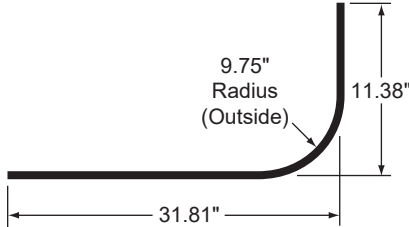

**10" RADIUS PANEL, PPW**  
Stoughton Number  
**DOR-FA30382**

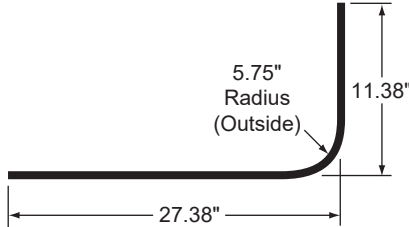

**5.7" RADIUS PANEL, PPW**  
Stoughton Number  
**DOR-FA30783**

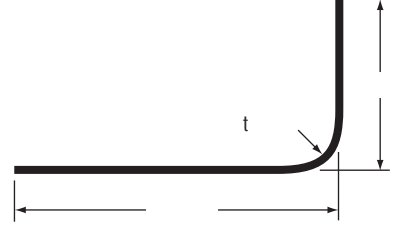

**RADIUS PANEL**  
Stoughton Number  
**DOR-FA3068267**

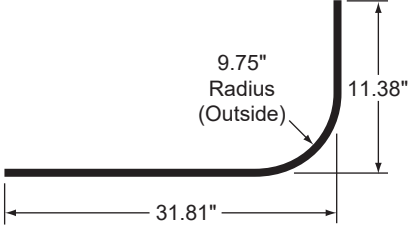

**10" RADIUS PANEL**  
Stoughton Number  
**DOR-FB30382**

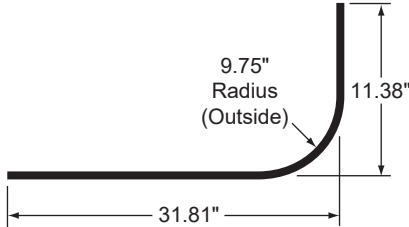

**10" RADIUS PANEL**  
Stoughton Number  
**DOR-FR30382**

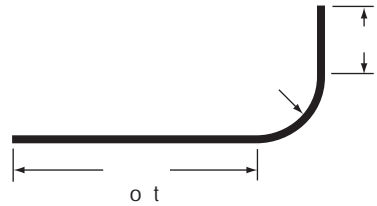

**5.7" RADIUS PANEL, SS W/PVC**  
Stoughton Number  
**DOR-FR30781**

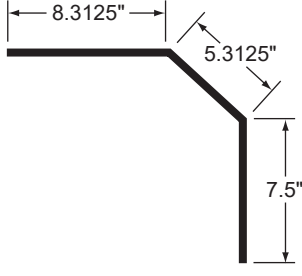

**RADIUS PANEL, BEVEL, FRONT**  
Stoughton Number  
**DOR-FR2804118**

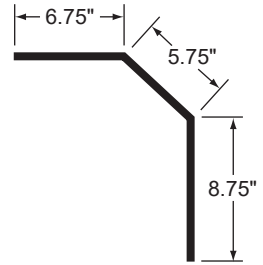

**110" RADIUS PANEL W/PVC, WHT**  
Stoughton Number  
**DOR-FR2898301**

Fruehauf

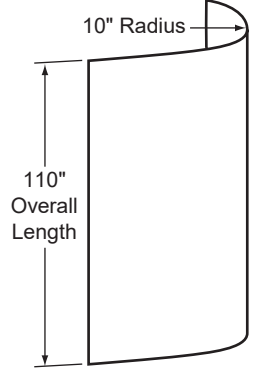

**10" RADIUS PANEL W/PVC, GRAY/WHT**  
Stoughton Number  
**FRU#WCC8051-SPA**

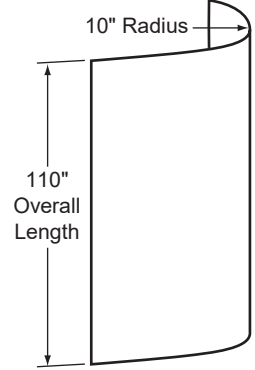

**10" RADIUS PANEL, MILL FINISH**  
Stoughton Number  
**FRU#WCC8051-SPN**

"Dorsey," "Fruehauf," "Great Dane," "Hyundai," "Kentucky," "Lufkin," "Monon," "Manac," "Pines," "Strick," "Trailmobile," "Utility," "Vanguard Trailer," and "Wabash" are trademarks of their respective owners and are used only to identify corresponding part numbers of Stoughton Part Sales, LLC. Stoughton Part Sales, LLC is not affiliated with the owners of these trademarks.

## CORNER PANELS

Fruehauf

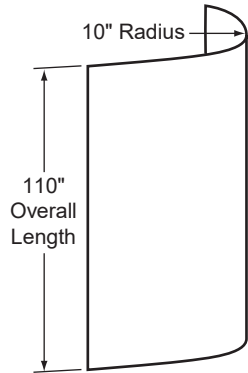

10" RADIUS PANEL W/PVC, PPW

Stoughton Number
FRU#WCC8051-SPW

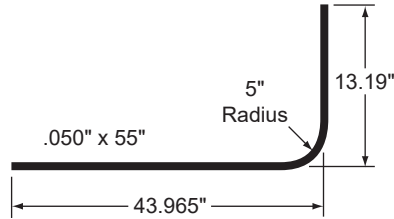

5" RADIUS PANEL

Stoughton Number
FRU#WCF9212-900W

## Great Dane

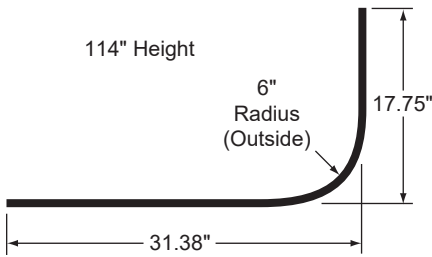

6" RADIUS CORNER PANEL, 45 x 114"

Stoughton Number
GD#00600

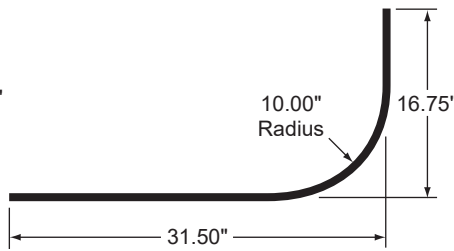

10" RADIUS CORNER PANEL, ALUM

Stoughton Number
GD#08014

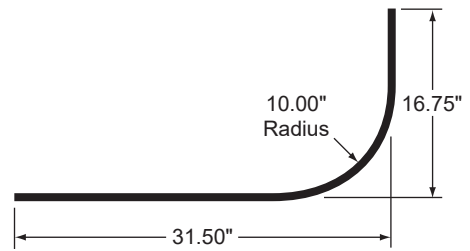

10" RADIUS PANEL, PPW

Stoughton Number
GD#08670

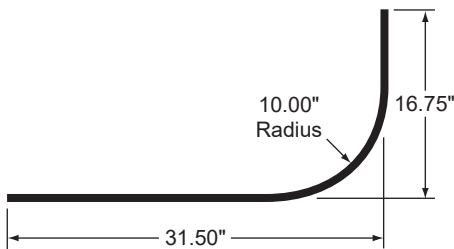

10" RADIUS PANEL

Stoughton Number
GD#08670-41

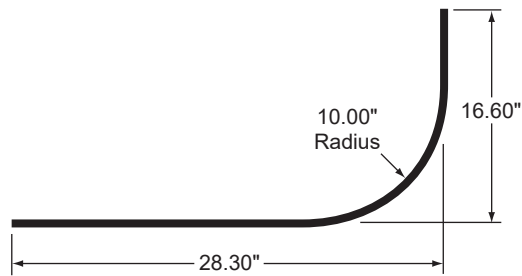

10" RADIUS PANEL, SS

Stoughton Number
GD#09416

## CORNER PANELS Great Dane

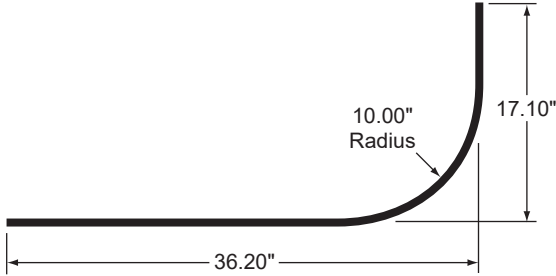

**10" RADIUS PANEL, PPW**

Stoughton Number
GD#14048

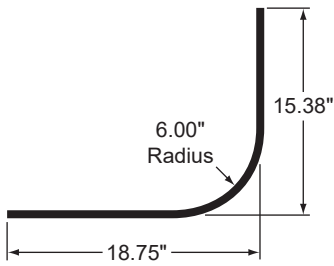

**6" RADIUS PANEL, CS 100-1/4"**

Stoughton Number
GD#40803901

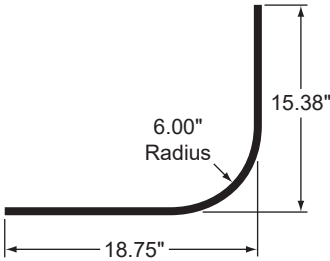

**6" RADIUS PANEL, SS**

Stoughton Number
GD#69102520
GD#69102520-015

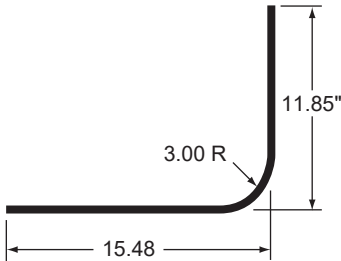

**RADIUS PANEL, PPW, CS/RS**

Stoughton Number
GD#69104743002

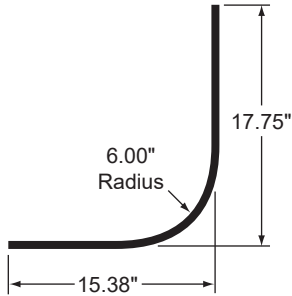

**CORNER RADIUS, PPG**

Stoughton Number
GD#69105418001

## Hyundai

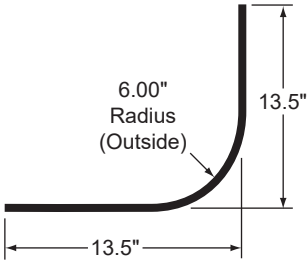

**6" RADIUS PANEL**

Stoughton Number
HY#2000-1761

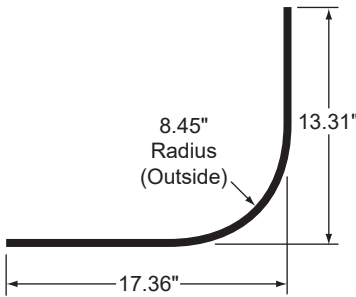

**8.45" RADIUS PANEL, WHT, ALUM**

Stoughton Number
HY#2000-2753

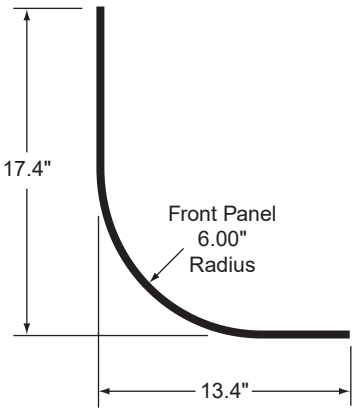

**6" RADIUS PANEL W/ PVC**

Stoughton Number
HY#2000-3024

## CORNER PANELS

Hyundai

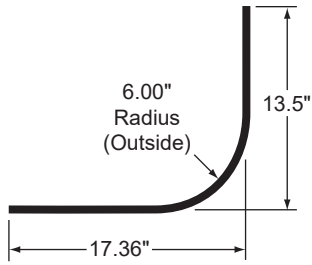

6" RADIUS PANEL, WHT, ALUM

Stoughton Number
HY#2000-8663

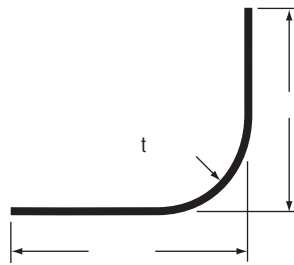

6" RADIUS PANEL, PPW W/PVC 114"

Stoughton Number
HY#2000-7553

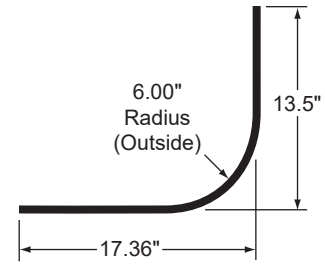

6" RADIUS PANEL, WHT, ALUM

Stoughton Number
HY#2001-0723

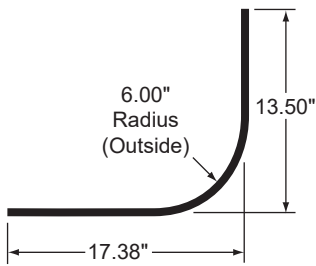

6" RADIUS PANEL W/PVC, WHT

Stoughton Number
HY#2001-3205

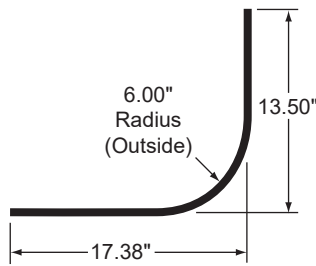

6" RADIUS PANEL W/PVC, BLK

Stoughton Number
HY#2001-4752

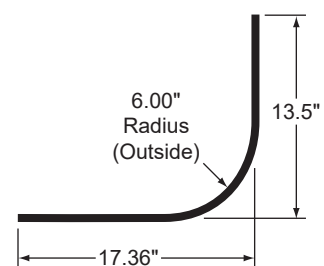

6" RADIUS PANEL, WHT, ALUM

Stoughton Number
HY#2001-6270

## Kentucky

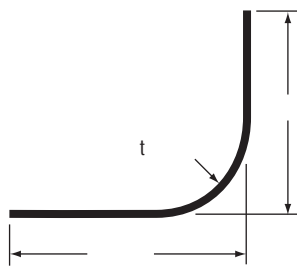

6" RADIUS PANEL, PPW W/PVC 114"

Stoughton Number
HY#2002-6492

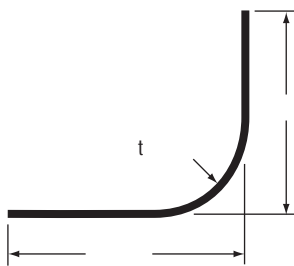

6" RADIUS PANEL, PPW W/PVC 114"

Stoughton Number
HY#2003-2332

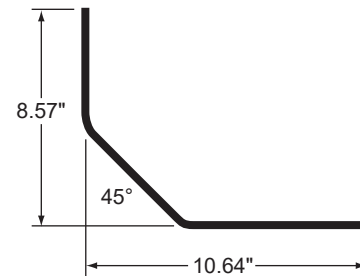

110° RADIUS PANEL, BEVELED, WHT

Stoughton Number
KY#15556-3

## CORNER PANELS

Lufkin

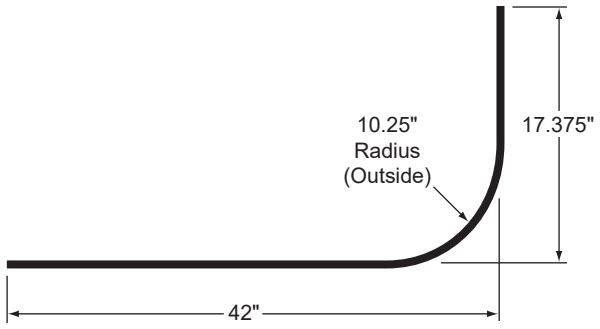

10.25" RADIUS PANEL, WHT, ALUM

Stoughton Number
LUF-A60252

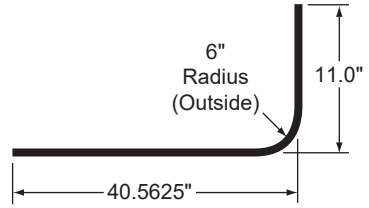

6" RADIUS PANEL, WHT, ALUM

Stoughton Number
LUF-A65611

Manac

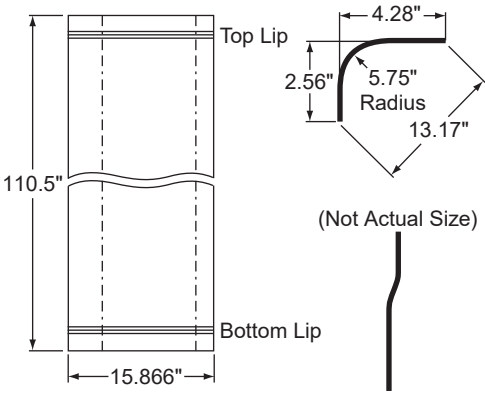

6" RADIUS PANEL, WHT, ALUM

Stoughton Number
MANAC#567-058

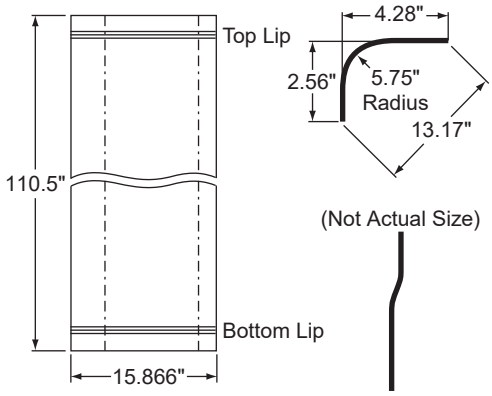

6" RADIUS PANEL, SST

Stoughton Number
MANAC#567-0581

Monon

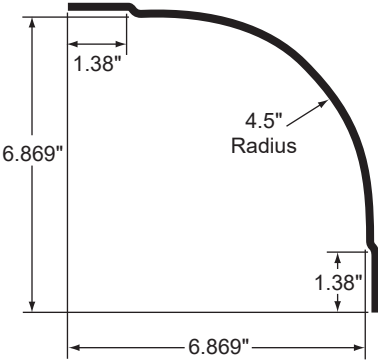

4.5" RADIUS PANEL

Stoughton Number
MON-AX042641

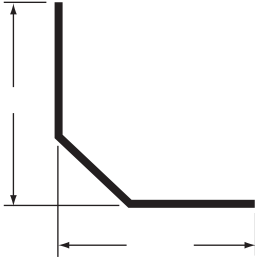

RADIUS PANEL, WHT, GALV

Stoughton Number
MON-EC033530

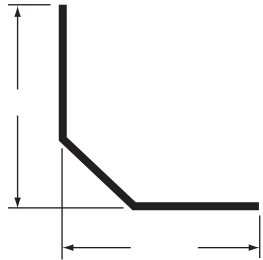

RADIUS PANEL, WHT, ALUM

Stoughton Number
MON-EC033532

"Dorsey," "Fruehauf," "Great Dane," "Hyundai," "Kentucky," "Lufkin," "Monon," "Manac," "Pines," "Strick," "Trailmobile," "Utility," "Vanguard Trailer," and "Wabash" are trademarks of their respective owners and are used only to identify corresponding part numbers of Stoughton Part Sales, LLC. Stoughton Part Sales, LLC is not affiliated with the owners of these trademarks.

## CORNER PANELS

### Monon

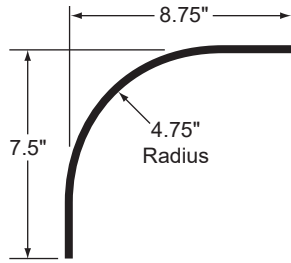

4.75" RADIUS PANEL, WHT, ALUM

Stoughton Number
MON-EC041408-B

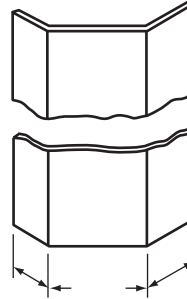

RADIUS PANEL

Stoughton Number
MON-V04-132

### Pines

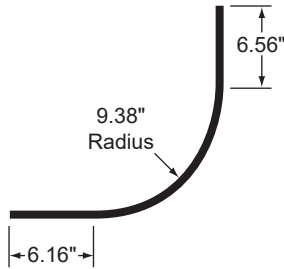

10" RADIUS PANEL, PPW

Stoughton Number
PINE ASB 5106-CS

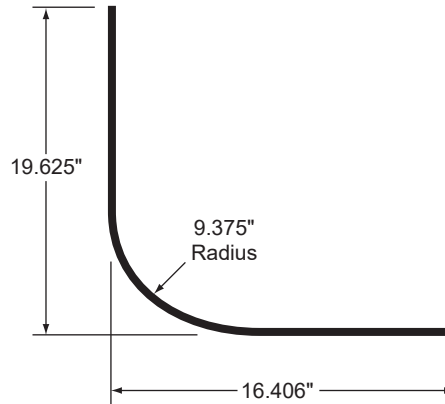

9.375" RADIUS PANEL W/PVC, WHT

Stoughton Number
PINE ASB 5164

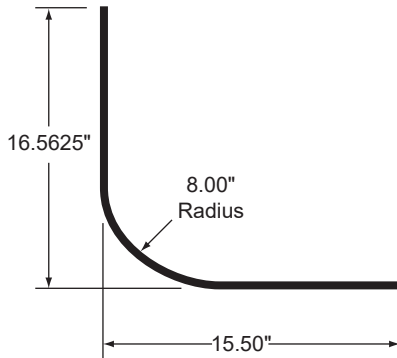

8" RADIUS PANEL W/PVC, WHT, 110"

Stoughton Number
PINE ASB 5559

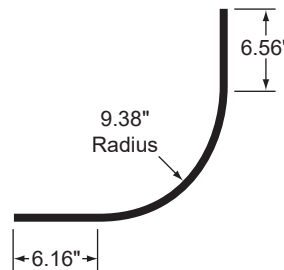

10" RADIUS PANEL, UNIV, PPW

Stoughton Number
PINE ASB 5950



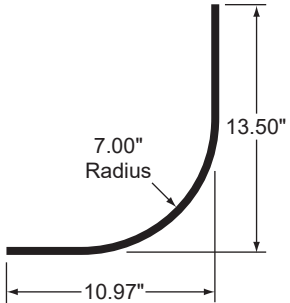

7" RADIUS PANEL, POLAR WHT

Stoughton Number
<b>STR#06876</b>

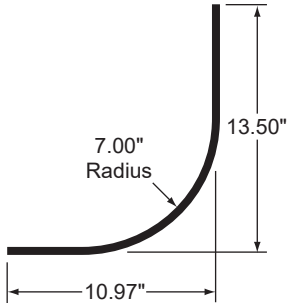

7" RADIUS PANEL, POLAR WHT, 114.5" LONG

Stoughton Number
<b>STR#06876-114.5</b>

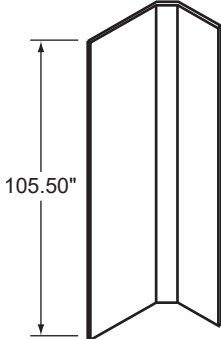
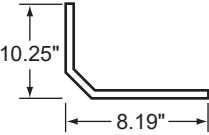

RADIUS PANEL W/PVC, STRICK, WHT

Stoughton Number
<b>STR#16313</b>

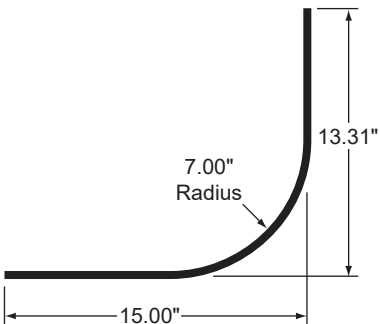

RADIUS PANEL (STRICK STYLE)

Stoughton Number
<b>STR#21887</b>

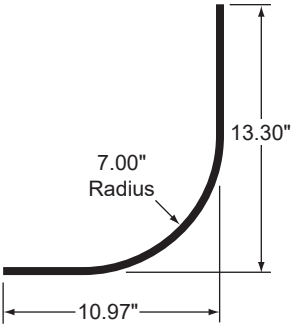

7" RADIUS PANEL, BARE, 94.5"

Stoughton Number
<b>STR#24799</b>

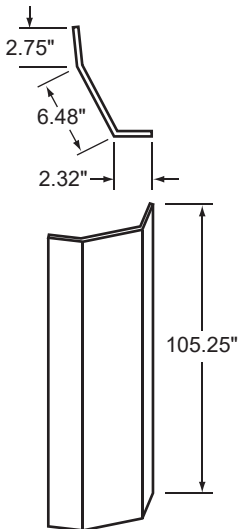

RADIUS PANEL, PPW, RS

Stoughton Number
<b>STR#29793</b>

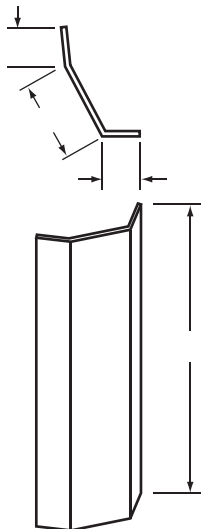

RADIUS PANEL, WHT, RS

Stoughton Number
<b>STR#29855</b>

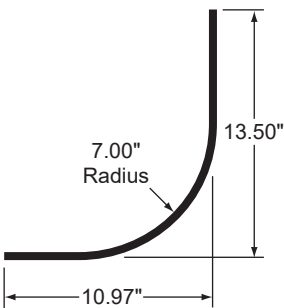

7" RADIUS PANEL, OUTSIDE, 107.5"

Stoughton Number
<b>STR#45305</b>

## CORNER PANELS

### Strick

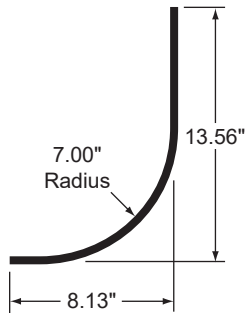

7" RADIUS PANEL W/PVC, POLAR WHT

Stoughton Number
<b>STR#52535</b>

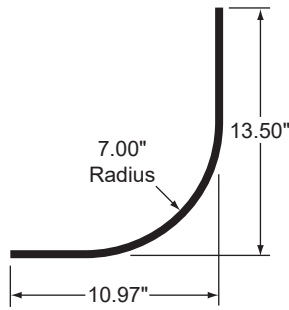

7" RADIUS PANEL, OUTSIDE, 105.5"

Stoughton Number
<b>STR-086876-105.5</b>

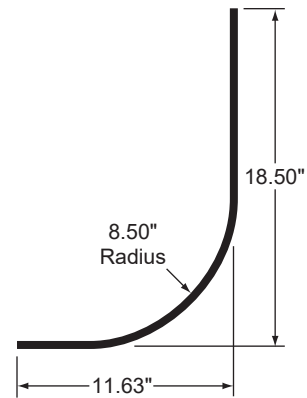

8.5" RADIUS PANEL, BARE, 114-7/8"

Stoughton Number
<b>STRAA63C40007421</b>

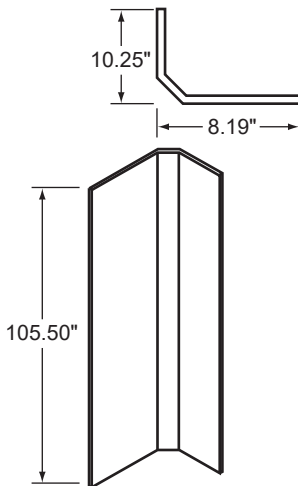

RADIUS PANEL, BEVEL, MILL FINISH

Stoughton Number
<b>STRAA63C72182421</b>

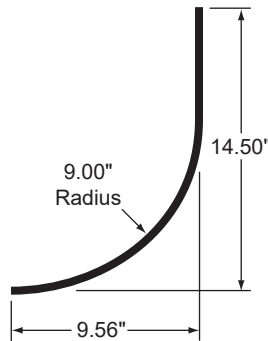

9.5" RADIUS PANEL, FRONT, 91.5"

Stoughton Number
<b>STRAA63C53381173</b>

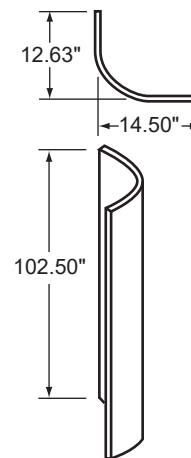

RADIUS PANEL, FRONT, 102.5"

Stoughton Number
<b>STRAA63C72822221</b>

Picture  
Not  
Available

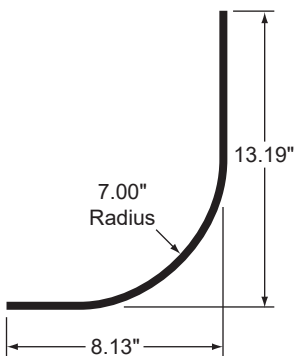

7" RADIUS PANEL, BARE, 105.5"

Stoughton Number
<b>STRAA63C73331601</b>

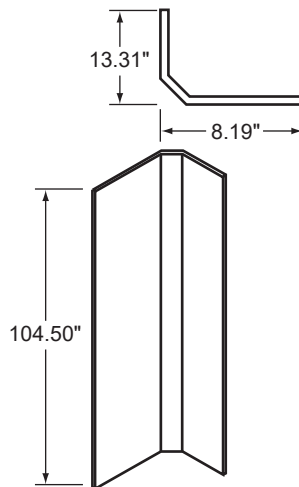

RADIUS PANEL, BEVEL, PPW, 104.5"

Stoughton Number
<b>STRAA63C74414903</b>

10" RADIUS PANEL, MILL FINISH

Stoughton Number
<b>STRAA63C-UNIVRSL</b>

## CORNER PANELS Trailmobile

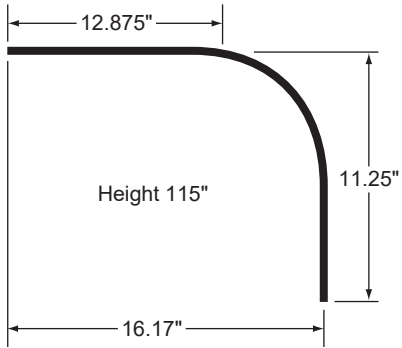

**RADIUS PANEL, TM RP102K-PPW**

Stoughton Number
TMRP102K-PPW

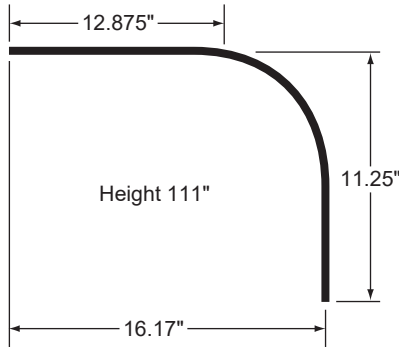

**5.75" RADIUS PANEL, SS, 111"**

Stoughton Number
TMRP102-SST

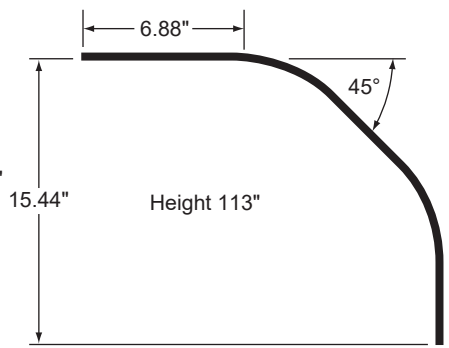

**RADIUS PANEL, ALUM, PPW, 113" TM**

Stoughton Number
TMRP-881-K-PPW

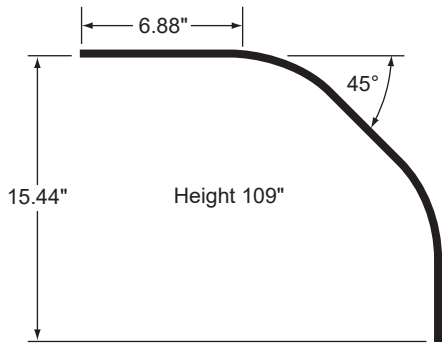

**RADIUS PANEL, TM RP102K-PPW**

Stoughton Number
TMRP-881-SST

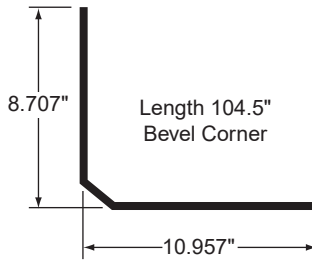

**5.75" RADIUS PANEL, PPW, 111"**

Stoughton Number
TMRP-883-K-PPW

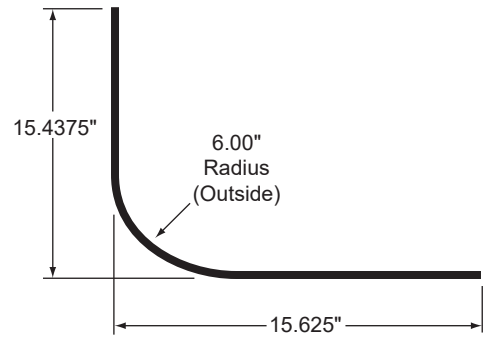

**6" RADIUS PANEL W/PVC, SS**

Stoughton Number
TMRP-883-K-SST

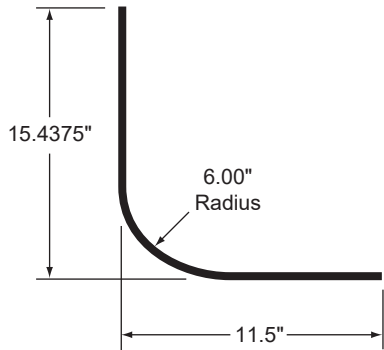

**6" RADIUS PANEL, TRAILMOBILE**

Stoughton Number
TMRP-958-K-PPW

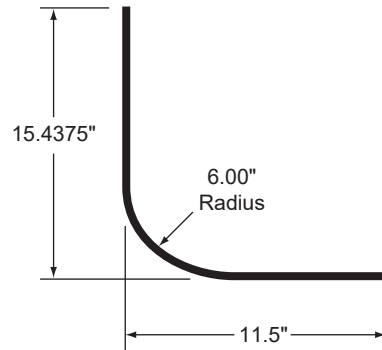

**6" RADIUS PANEL W/PVC, SS, 111.5"**

Stoughton Number
TMRP-958-SST



## CORNER LINERS Stoughton

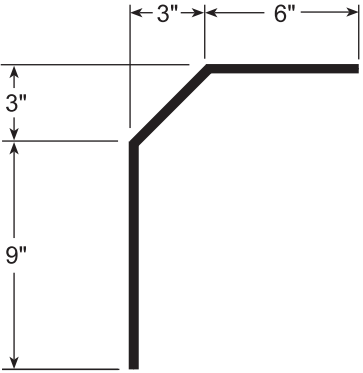

Stoughton Number	Length	Material
01 08525 XXX 00	107 5/8"	.063 Galvanized Steel

Replaces 01 10794 006 00

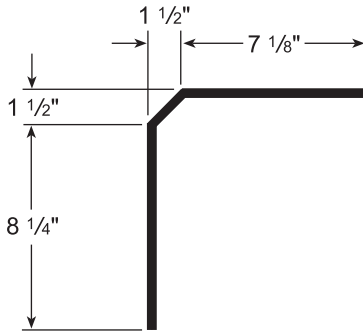

Stoughton Number	Length	Material
01 09920 XXX 00	107 3/8"	.063 Galvanized Steel

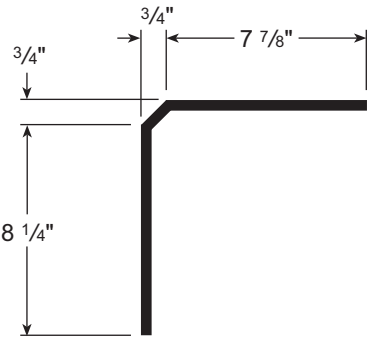

Stoughton Number	Length	Material
01 11010 006 00	107 3/8"	.063 Galvanized Steel

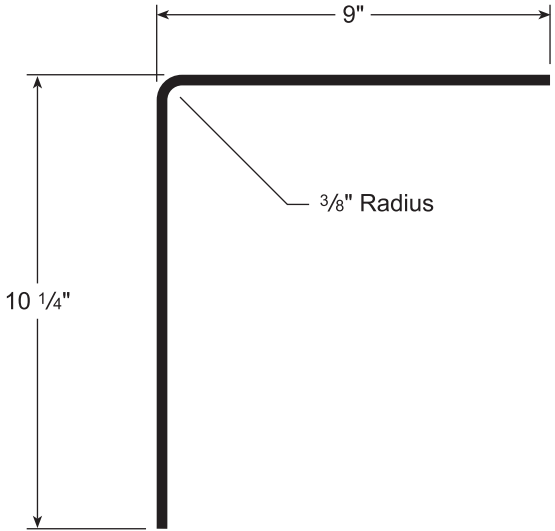

Stoughton Number	Length	Material
01 11601 002 00	107 5/8"	.063 Galvanized Steel

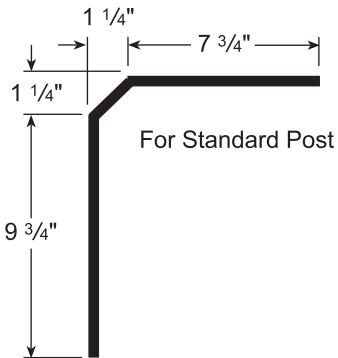

Stoughton Number	Length	Material
01 12997 006 00	107 3/8"	.063 Galvanized Steel

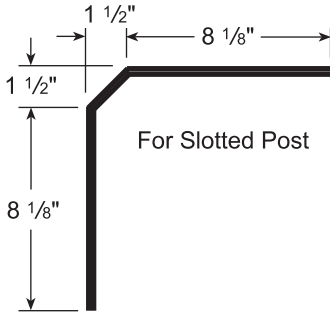

Stoughton Number	Length	Material
01 12998 006 00	107 3/8"	.063 Galvanized Steel

Replaces 01 12999 000 00

**CORNER LINERS**

Stoughton

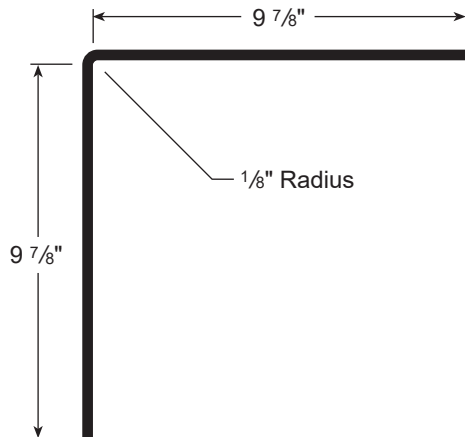

Stoughton Number	Length	Material
01 13685 007 00	110 1/8"	.063 Galvanized Steel

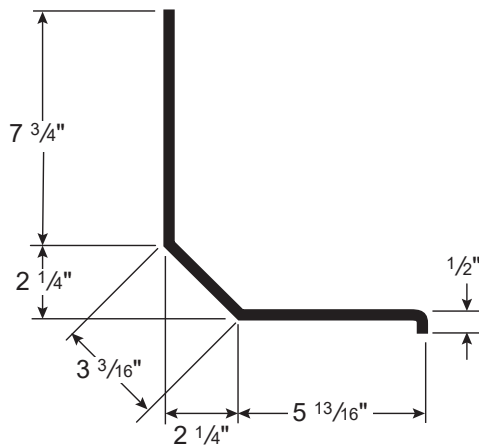
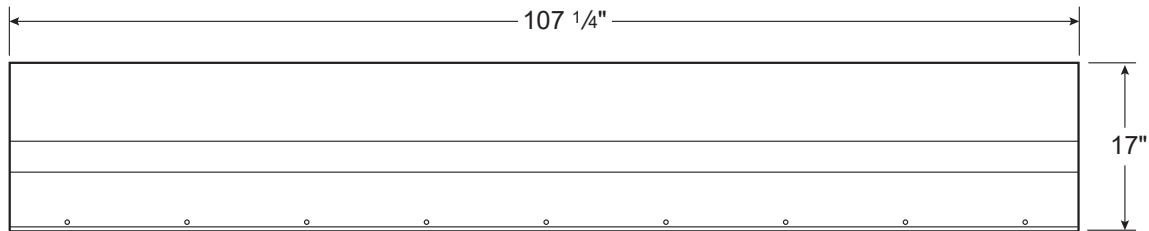

Stoughton Number	Model	Body Height Range	Material
01 19798 X06 00	AVXW	116 1/2" - 119 1/16"	Galvanized Steel

Specify Roadside or Curbside.

## CORNER LINERS Stoughton

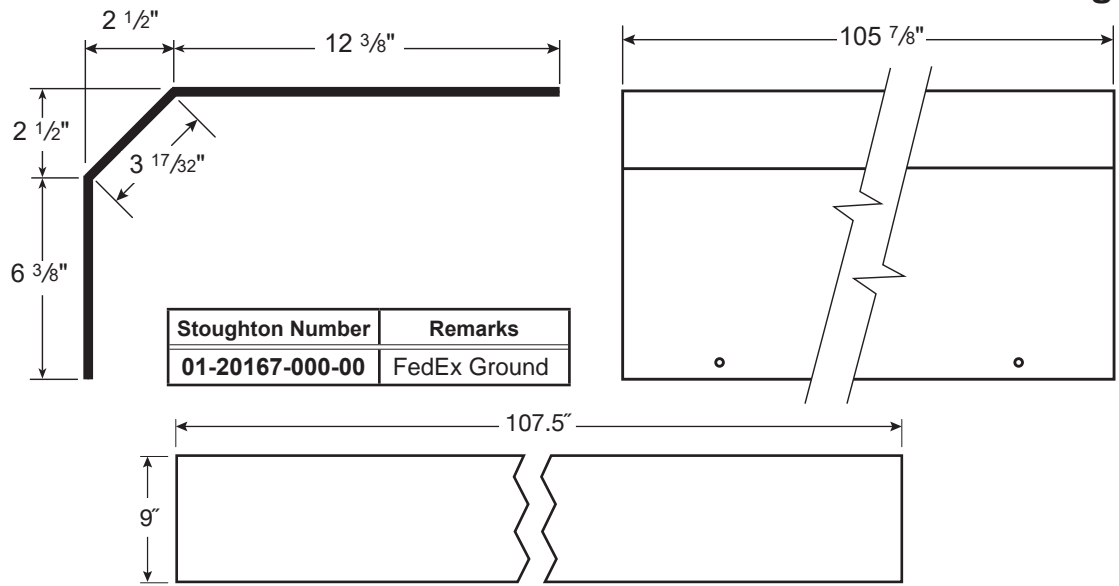

Stoughton Number	Remarks
01-20167-000-00	FedEx Ground

Z PLATE

Stoughton Number	Material
01-21144-006-00	Aluminum

## Frehauf

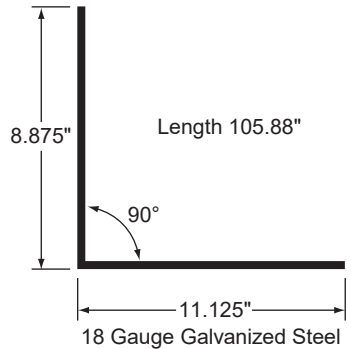

CORNER POST LINER, GALV, 105.88"

Stoughton Number
FRU#WCF-9230-1

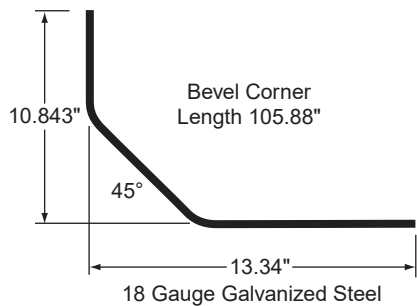

CORNER POST LINER, WHT, GALV

Stoughton Number
FRU#WCD1971-6

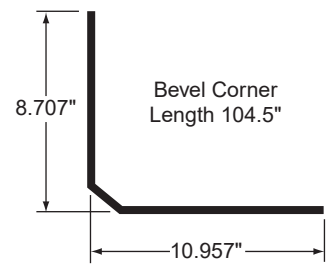

CORNER LINER, FRUEHAUF, GALV

Stoughton Number
FRU#WCD-3596-11

## Hyundai

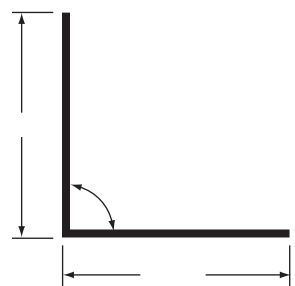

CORNER LINER

Stoughton Number
HY#2000-0335

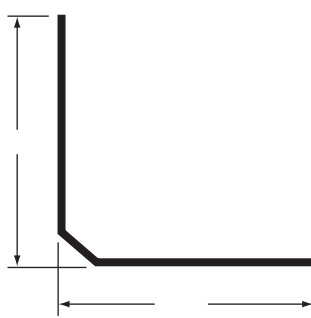

CORNER LINER

Stoughton Number
HY#2000-5584

"Dorsey," "Fruehauf," "Great Dane," "Hyundai," "Kentucky," "Lufkin," "Monon," "Manac," "Pines," "Strick," "Trailmobile," "Utility," "Vanguard Trailer," and "Wabash" are trademarks of their respective owners and are used only to identify corresponding part numbers of Stoughton Part Sales, LLC. Stoughton Part Sales, LLC is not affiliated with the owners of these trademarks.

## CORNER LINERS

### Strick

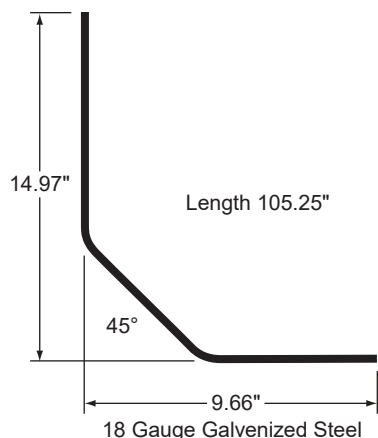

CORNER LINER, G90, WHT, GALV

Stoughton Number
STR#06539

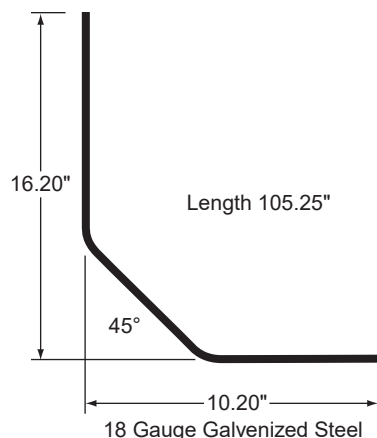

CORNER LINER, G90, WHT, GALV

Stoughton Number
STR#06782

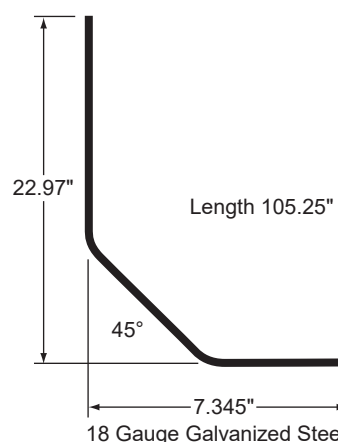

CORNER LINER, G90, WHT, GALV

Stoughton Number
STR#45309

### Trailmobile

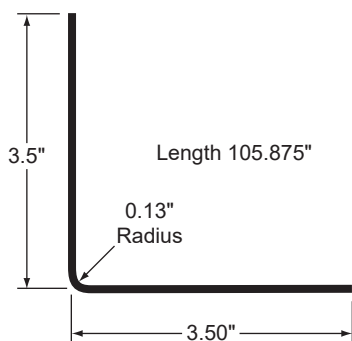

CORNER LINER, WHT, 105.875"

Stoughton Number
TM508-15-216-22

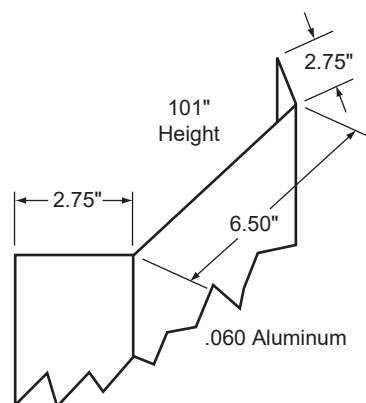

INNER RADIUS, REEFER, WHT, 101"

Stoughton Number
TM508-20-29-31

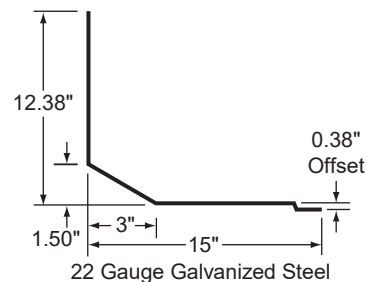

FRONT CORNER LINER, 106", GALV

Stoughton Number
TM700-519-1

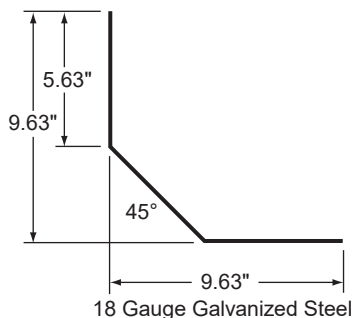

CORNER LINER, G90 GALV, MILL

Stoughton Number
TM9513-1-1458A

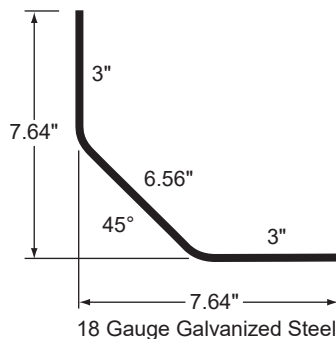

CORNER LINER, G90 GALV, MILL

Stoughton Number
TM9519-1-507-E9

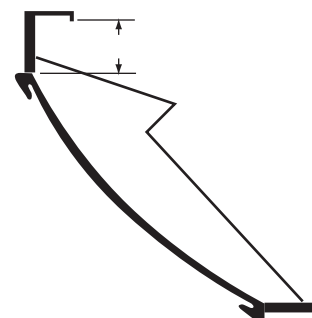

CORNER RADIUS, COCA COLA RED

Stoughton Number
TMRP-205-CCR



## CORNER POSTS

Stoughton

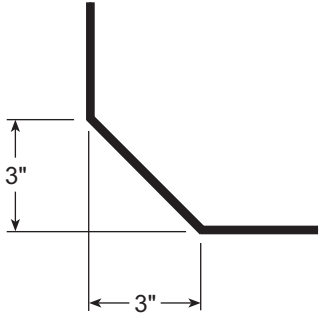

Stoughton Number	Length	Material
01 08808 XXX 00	89 3/4"	Aluminum

### Great Dane

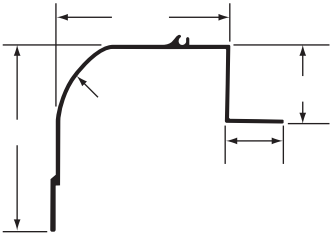

CORNER POST, ALUM, 112.5"

Stoughton Number
GD#60424104

### Monon

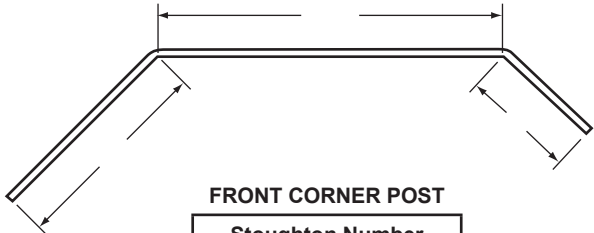

FRONT CORNER POST

Stoughton Number
MON-AI004544

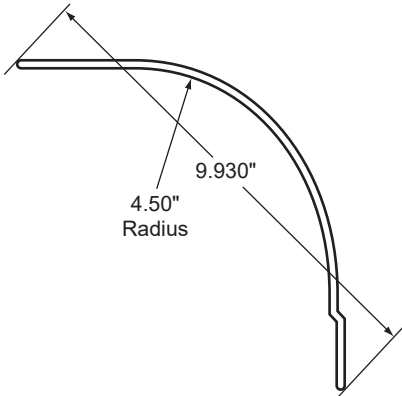

FRONT CORNER POST

Stoughton Number
MON-AX054344

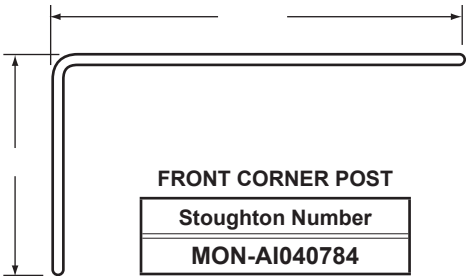

FRONT CORNER POST

Stoughton Number
MON-AI040784

## CORNER POSTS

### Pines

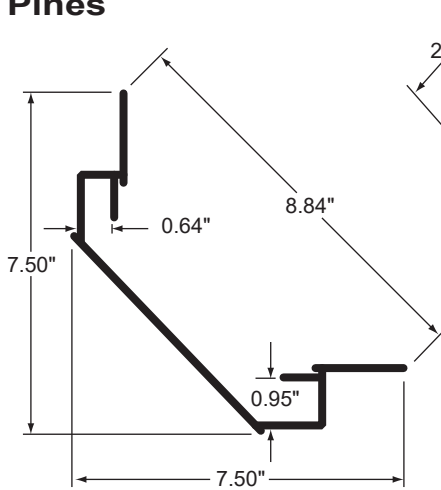

**FRONT CORNER POST**

Stoughton Number
<b>PINE AE333011031</b>

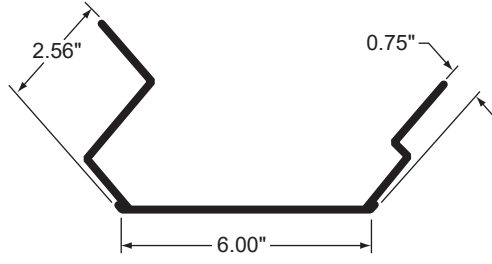

**CORNER POST, 110.31", MILL**

Stoughton Number
<b>PINE AE333201030</b>

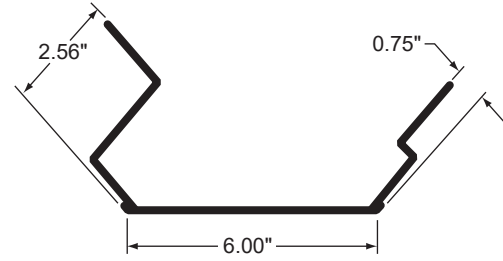

**CORNER POST, 110.31", ALUM**

Stoughton Number
<b>PINE AE333201031</b>

### Trailmobile

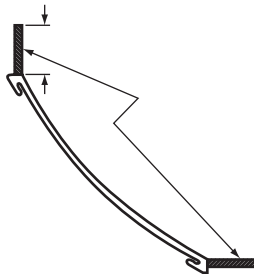

**CORNER POST, 116.13", ALUM**

Stoughton Number
<b>TMRP115-MFA</b>

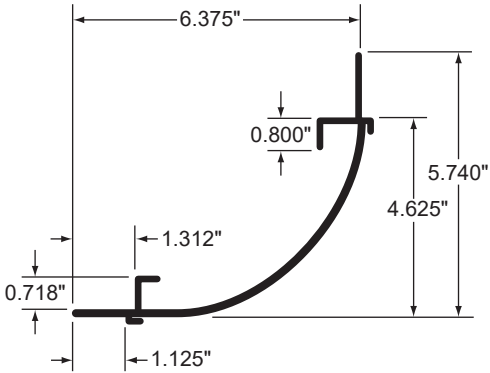

CORNER POST, EXTRU, 116.5" L, PPW

Stoughton Number
UT-01-6500-0-155

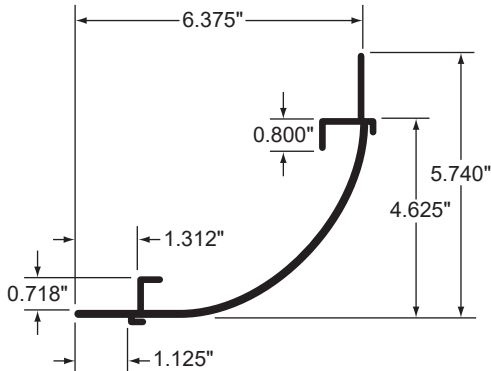

CORNER POST, EXTRU, 116.5" L, MILL

Stoughton Number
UT-01-6500-156

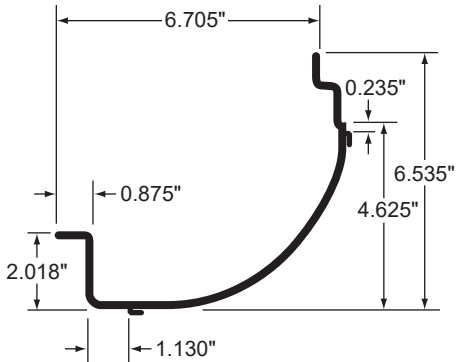

CORNER POST, 120" L

Stoughton Number
UT-01-6500-159

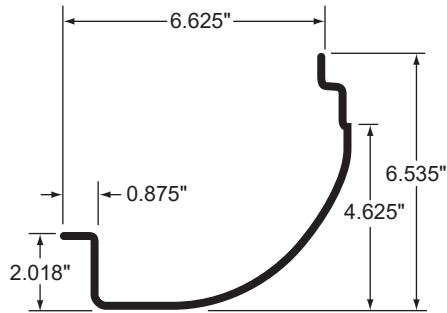

CORNER POST, EXTRU, 120" L, WHT

Stoughton Number
UT-01-6500-160

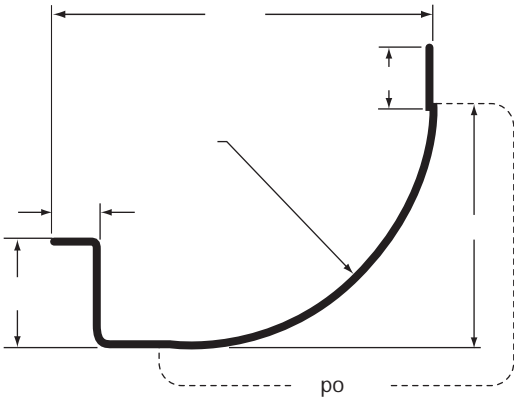

CORNER POST, MILL, 120"

Stoughton Number
UT-01-6500-164

**CORNER POSTS**

Wabash

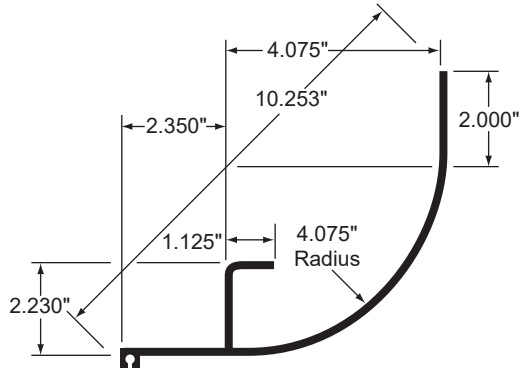

5" CORNER POST, EXTRU, 118" L, ALUM

Stoughton Number
WAB-E0081200

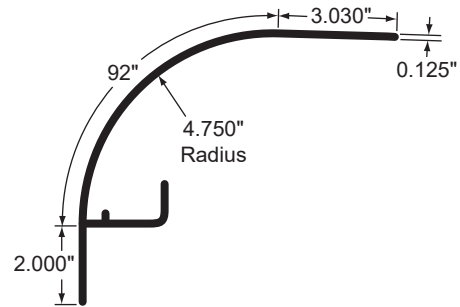

CORNER POST

Stoughton Number
WAB-E8351200

## FRONT WALL POSTS Stoughton

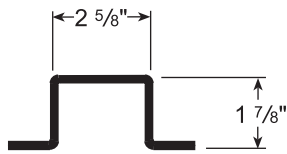

Stoughton Number	Length	Material
01 08034 XXX 00	111 3/4"	Galv. Steel

Replaces 01 04993 000 00, 01 06360 000 00 and 01 06668 000 00

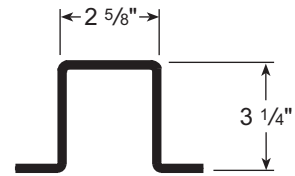

Stoughton Number	Length	Material
01 10034 XXX 00	107 3/4"	Steel
01 10034 001 00	109 3/4"	Steel-Punched

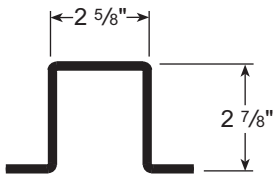

Stoughton Number	Length	Material
01 09031 XXX 00	107 3/4"	Steel

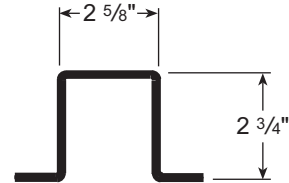

CONTAINER

Stoughton Number	Length	Material
01 09848 XXX 00	105 1/4"	Steel

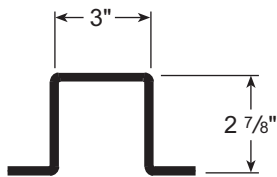

Stoughton Number	Length	Material
01 04109 XXX 00	111 1/8"	Steel

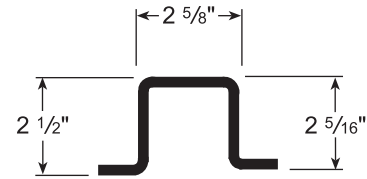

UNPUNCHED OUTER PV

Stoughton Number	Length	Material
01 14708 XXX 00	109 13/16"	Galv. Steel

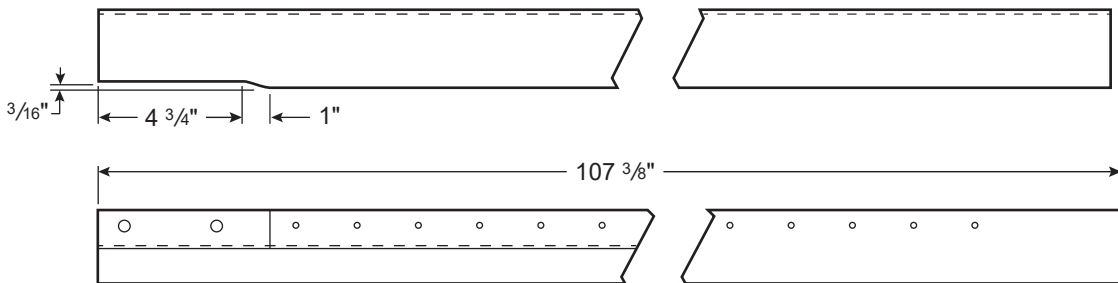

Roadside Shown  
Curbside Opposite

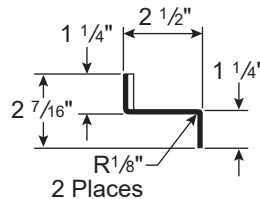

### Z PLATE POSTS

Stoughton Number	Remarks
01 20835 106 00	Roadside
01 20835 206 00	Curbside

# FRONT WALL POSTS

Stoughton

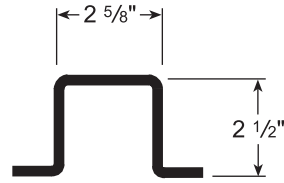

Stoughton Number	Length	Material
03 14275 109 81	109 7/8"	Galv. Steel

Replaces 01 09918 000 00, same as 01 14707 000 00

Cross-section

Side View

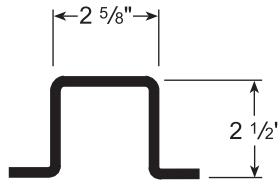
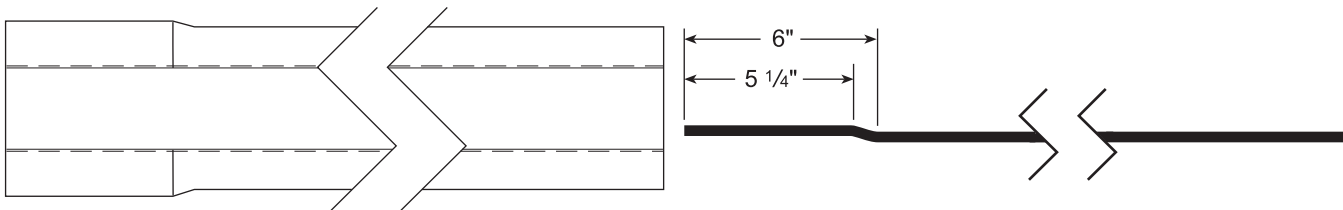

OFFSET BOTTOM

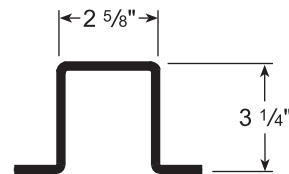

OFFSET BOTTOM

Stoughton Number	Length	Material	Remarks
01 12992 006 00	107 3/8"	Galv. Steel	Punched
01 19981 006 00	107 3/8"	Galv. Steel	Punched
03 12991 110 00	110"	Galv. Steel	Unpunched

Stoughton Number	Length	Material	Remarks
01 19643 000 00	106 3/4"	Galv. Steel	Punched
03 15456 107 38	107 3/8"	Galv. Steel	Unpunched
03 19516 106 75	106 3/4"	Galv. Steel	Unpunched

Call with trailer VIN (Serial Number) for availability of "punched" front wall posts

## FRONT WALL POSTS Lufkin

### Great Dane

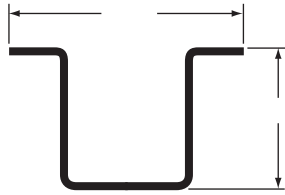

NOSE POST, STEEL, UNPUNCHED

Stoughton Number	Length
GD#09432-P	110'
GD#09432	116'

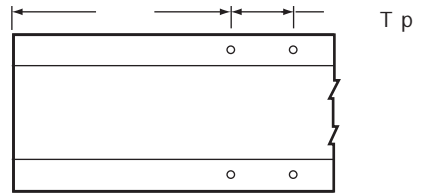

NOSE POST, GALV, 107.188"

Stoughton Number
LUF-E7087414

### Manac



107.75" NOSE POST, STEEL

Stoughton Number
MANAC#501-4085

### Trailmobile

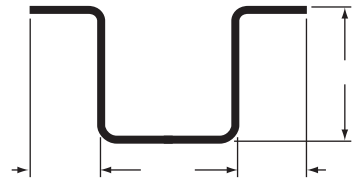

NOSE POST, 116", STEEL, PUNCHED

Stoughton Number
TM90-4-2400P0117

### Utility

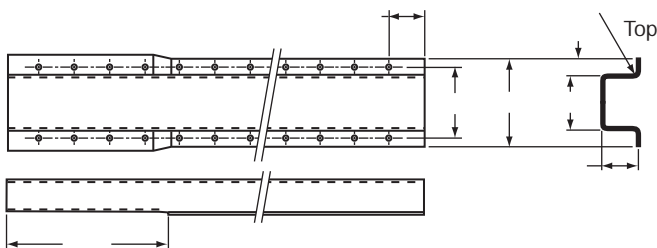

NOSE POST, STEEL, UNPUNCHED, 116"

Stoughton Number
UT-03-6512-0-042

### Wabash

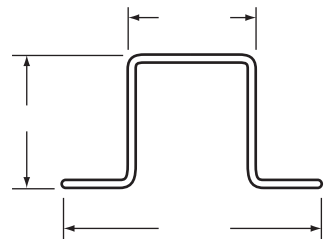

NOSE POST, STEEL, UNPUNCHED

Stoughton Number
WAB-04S00020

## NOSE RAILS

Stoughton

### Example Extruded Nose Rail with Corner Castings

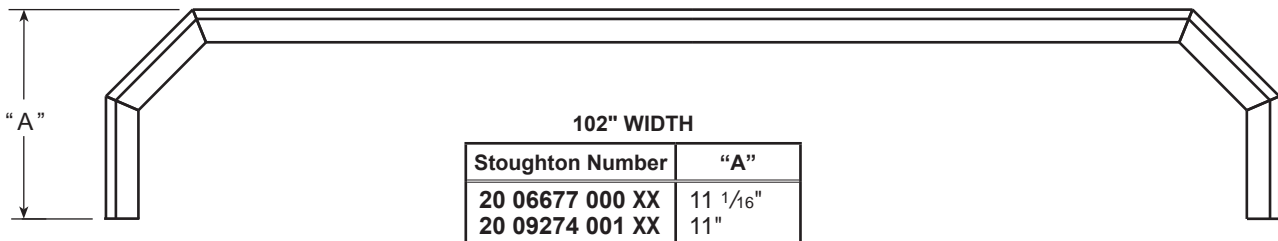
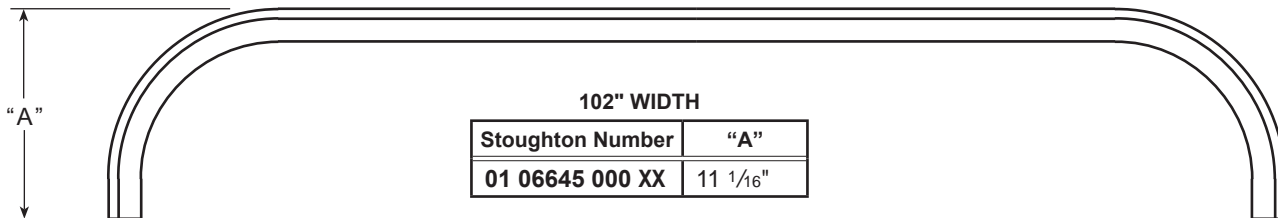
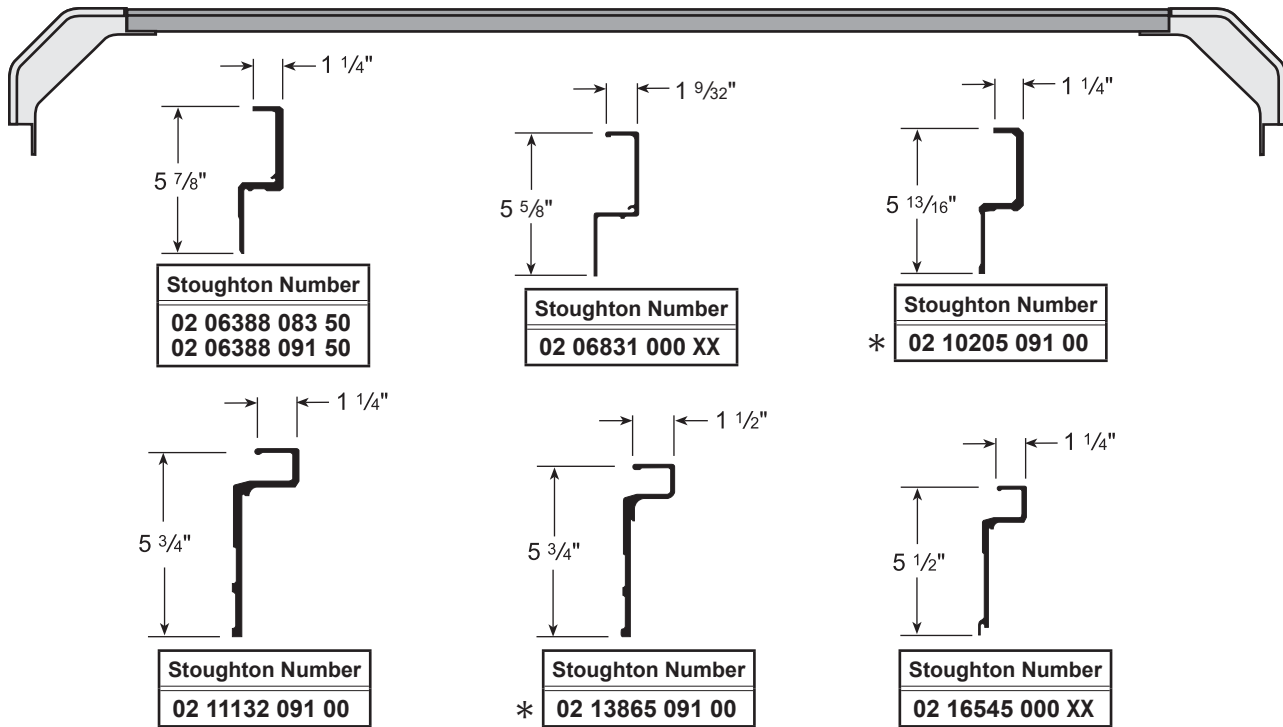

\* Refers to Container



## NOSE RAILS Dorsey



NOSE RAIL, 10" RADIUS

Stoughton Number
DOR-251047902



NOSE RAIL, 10" RADIUS

Stoughton Number
DOR-251122102



NOSE RAIL, 6" RADIUS

Stoughton Number
DOR-251128702

## Fruehauf

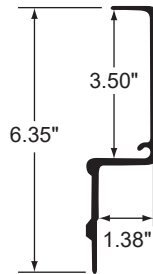

102" NOSE RAIL

Stoughton Number
FRU#WCF3721-1

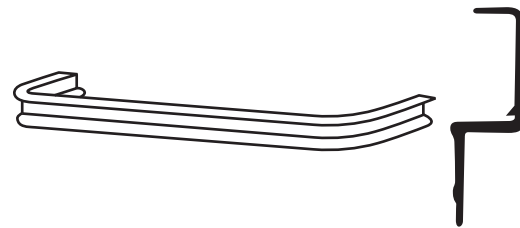

102" NOSE RAIL

Stoughton Number
FRU#WCF3959-1

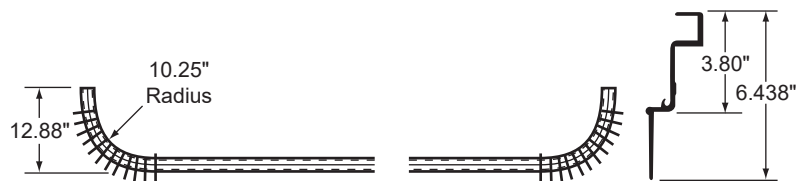

FRONT TOP RAIL, UNPUNCHED, 102"

Stoughton Number
FRU#WCF5903-901

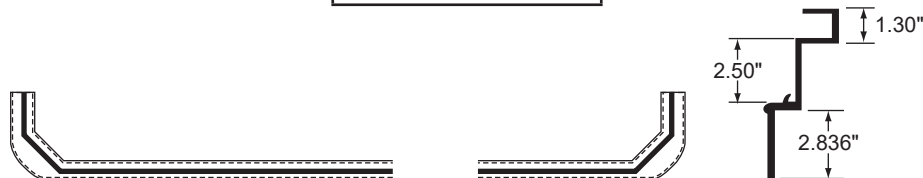

NOSE RAIL, WELDED HEADER

Stoughton Number
FRU#WCF9003-2

## NOSE RAILS

### Great Dane

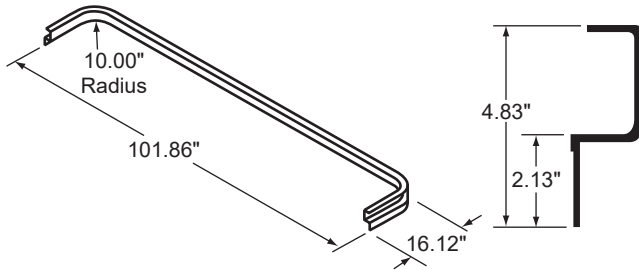

10" NOSE RAIL, RADIUS 102"

Stoughton Number
GD#76340

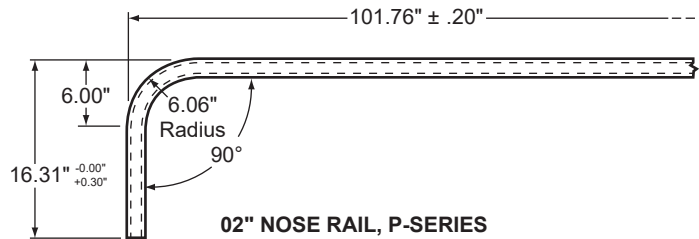

02" NOSE RAIL, P-SERIES

Stoughton Number
GD#41200891

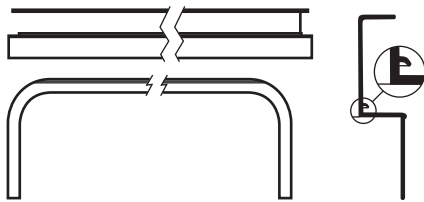

NOSE RAIL, 6" RADIUS 101.75"

Stoughton Number
GD#41201967

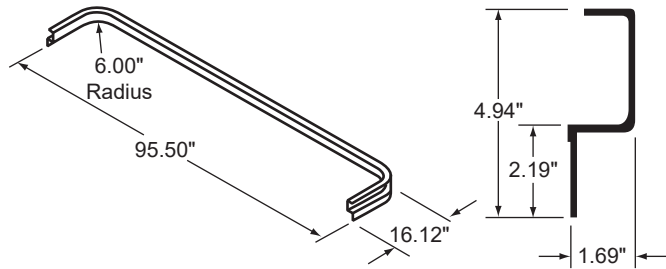

NOSE RAIL, 96" WIDE

Stoughton Number
GD#41203162

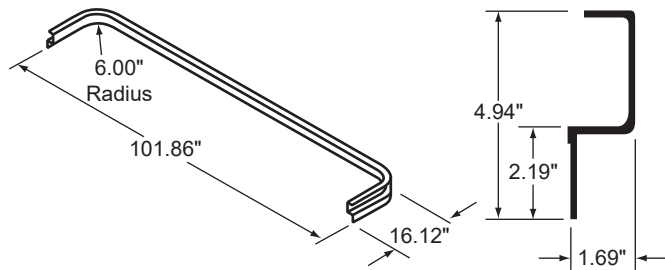

NOSE RAIL, 102" WIDE

Stoughton Number
GD#41203163

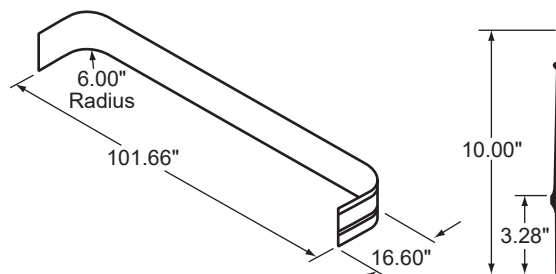

FRONT BOTTOM RAIL, ALUM, 102" WIDE

Stoughton Number
GD#41203178

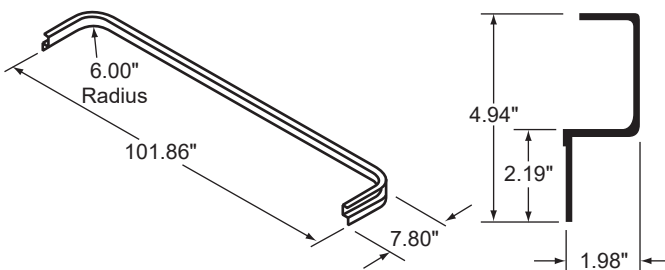

NOSE RAIL, 102" WIDE

Stoughton Number
GD#41203196

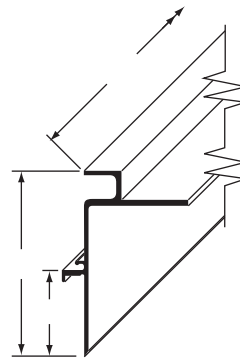

NOSE RAIL, 93"

Stoughton Number
GD#4300001

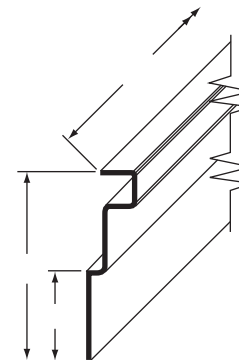

NOSE RAIL, 91.25"

Stoughton Number
GD#60311601

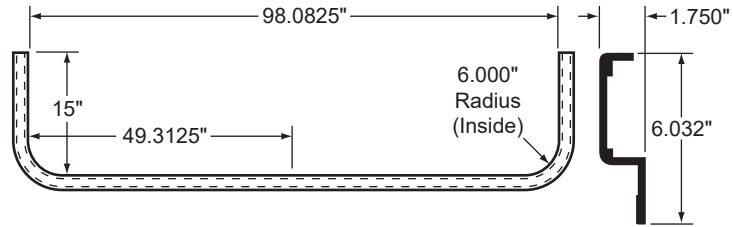

**NOSE RAIL, 6" RADIUS, 102"**

Stoughton Number
GD#69103212

## Hyundai

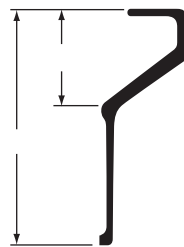

**NOSE RAIL**

Stoughton Number
HY#1000-7412

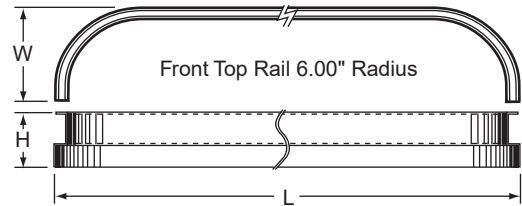

**NOSE RAIL**

Stoughton Number
HY#1000-3146

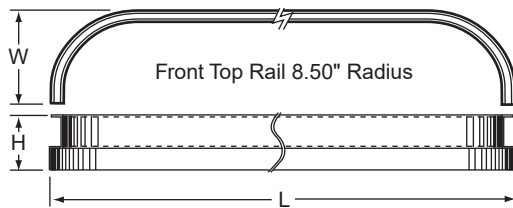

**NOSE RAIL**

Stoughton Number
HY#1000-5098

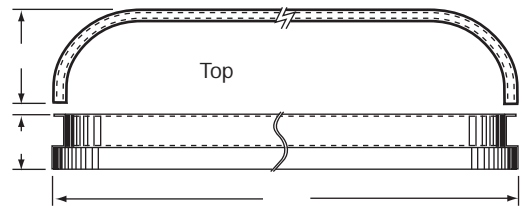

**NOSE RAIL, 4" RADIUS**

Stoughton Number
HY#1001-6265

## NOSE RAILS

### Trailmobile

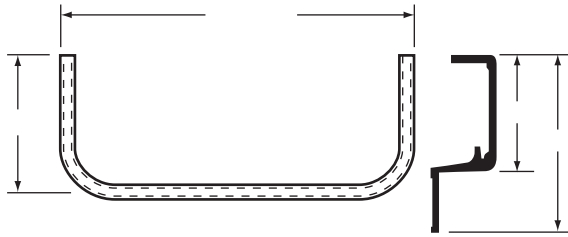

6" NOSE RAIL, ALUM, 102-3/8"

Stoughton Number
TM511-1-130B

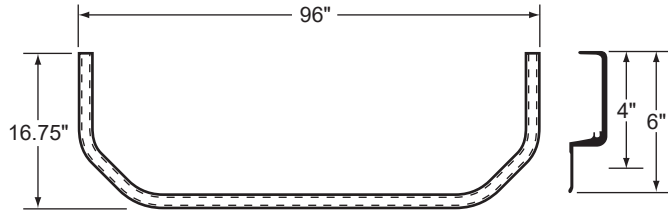

NOSE RAIL, O-MODEL, 96" LONG

Stoughton Number
TM511-1-109-2

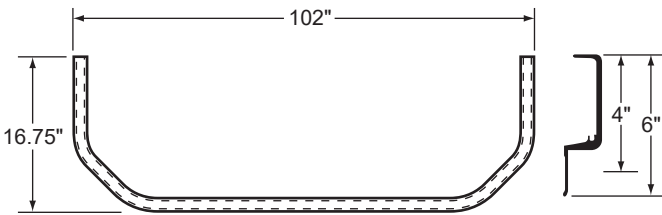

NOSE RAIL, O-MODEL

Stoughton Number
TM511-1-109-2-1

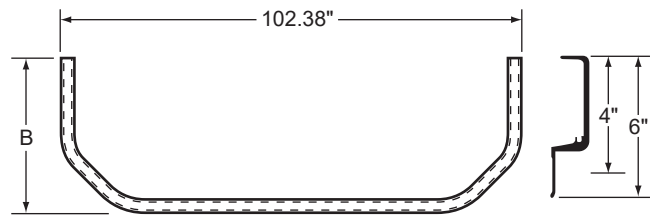

6" NOSE RAIL, TYPE O-MODEL, ALUM

Stoughton Number
TM511-1-109-2-2

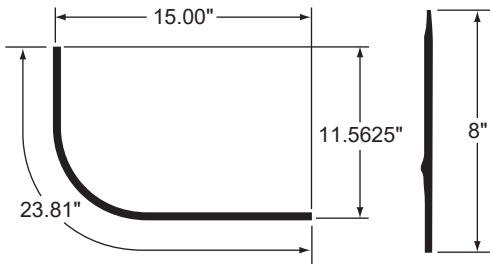

CORNER RAIL, LOWER LEFT HAND

Stoughton Number
TM511-1-137L-B-A

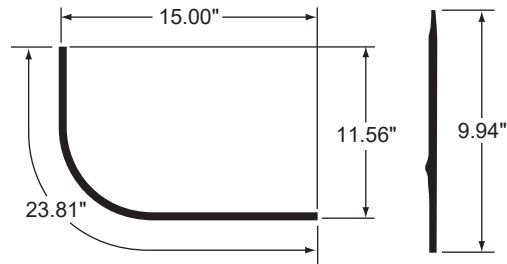

CORNER RAIL, LOWER LEFT HAND

Stoughton Number
TM511-1-137L-B-B

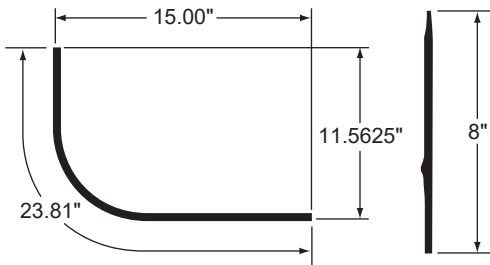

CORNER RAIL, LOWER RIGHT HAND

Stoughton Number
TM511-1-137R-B-A

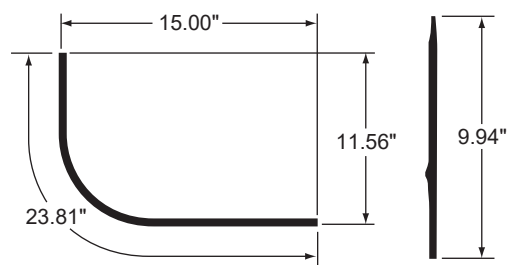

CORNER RAIL, LOWER RIGHT HAND

Stoughton Number
TM511-1-137R-B-B

## NOSE RAILS Trailmobile

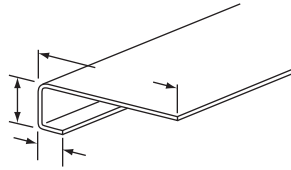

NOSE RAIL, ALUM, REINF, 126"

Stoughton Number
TM90-4-1563-0126

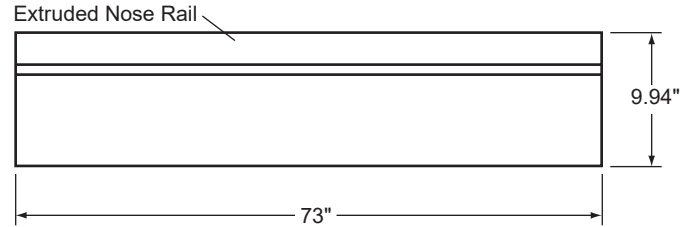

LOWER FRONT RAIL, 73"

Stoughton Number
TM90-4-2313-0-73

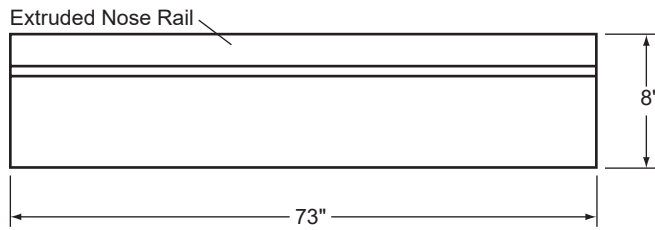

LOWER FRONT RAIL, 73"

Stoughton Number
TM90-4-2353-0-73

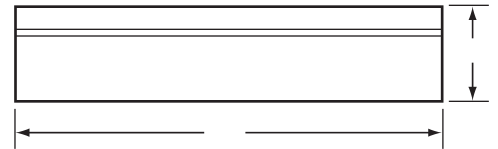

LOWER FRONT RAIL, 88"

Stoughton Number
TM90-4-2353-0-88

## Utility

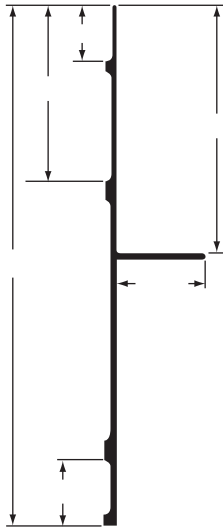

LOWER NOSE RAIL, 91"

Stoughton Number
UT-01-6650-0-155

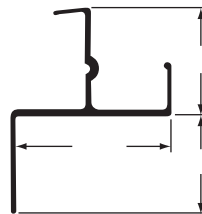

TOP RAIL, FRONT, ALUM, 2000R X 89"

Stoughton Number
UT-01-6650-0-071

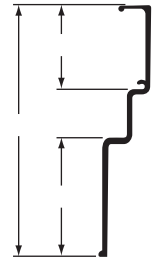

TOP RAIL, FRONT, ALUM, 101-7/8"

Stoughton Number
UT-03-6650-0-310

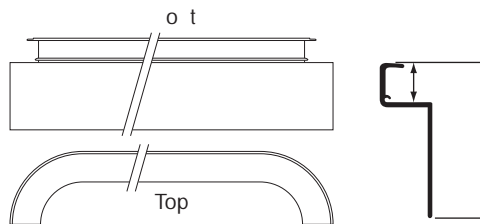

NOSE RAIL

Stoughton Number
UT-03-6650-0-423

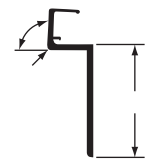

TOP RAIL, FRONT, ALUM, 101-7/8"

Stoughton Number
UT-03-6650-0-510

## NOSE RAILS

### Vanguard Trailers

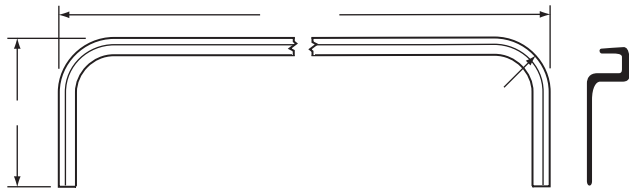

NOSE RAIL, ALUM

Stoughton Number
VAN-FWP00027

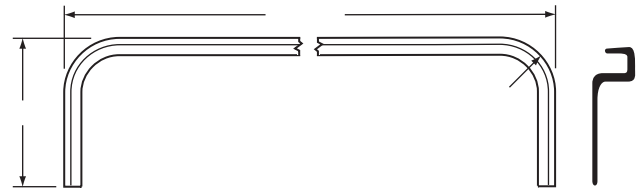

NOSE RAIL, ALUM, 102"

Stoughton Number
VAN-FWP00063

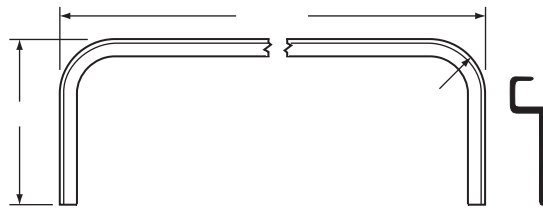

NOSE RAIL, ALUM

Stoughton Number
VAN-FWP00100

## Wabash

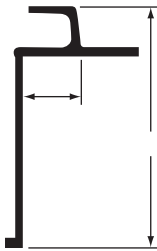

5" TRAILER HEADER, PLATE, 102"

Stoughton Number
WAB-04000001

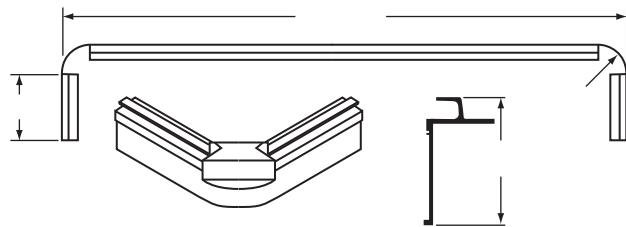

NOSE RAIL

Stoughton Number
WAB-04000015

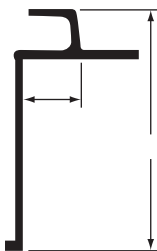

5" TRAILER HEADER, PLATE, 102"

Stoughton Number
WAB-04000072

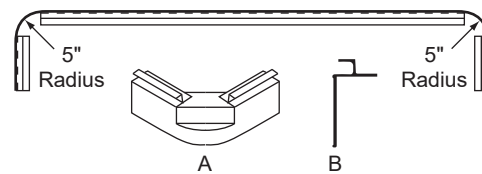

5" TRAILER HEADER, PLATE, 102"

Stoughton Number
WAB-04000595

## NOSE RAILS Wabash

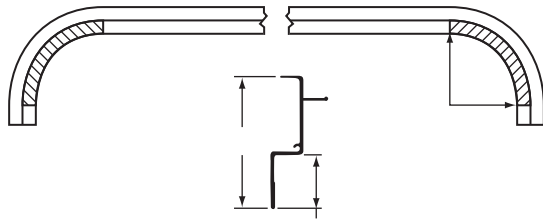

**NOSE RAIL, 102"**  
Stoughton Number  
**WAB-04A00005**

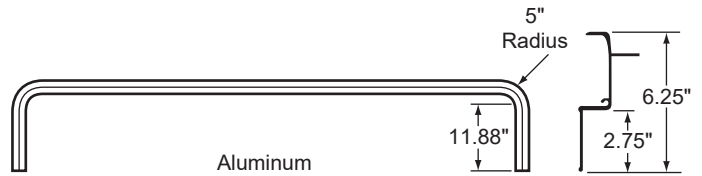

Aluminum  
**5" NOSE RAIL, ALUM, 102"**  
Stoughton Number  
**WAB-04A00211**

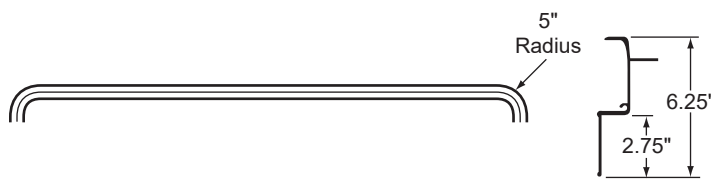

**NOSE RAIL, WABASH STYLE, ALUM**  
Stoughton Number  
**WAB-04A00218**

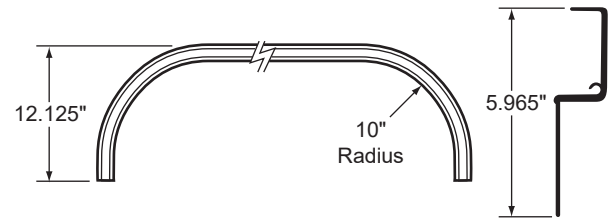

**10" NOSE RAIL, R-REEFER, 102"**  
Stoughton Number  
**WAB-04A00735**

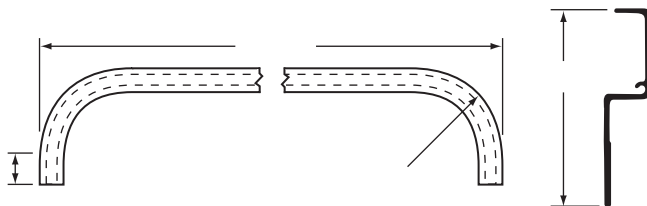

**NOSE RAIL, ALUM**  
Stoughton Number  
**WAB-04A00800**

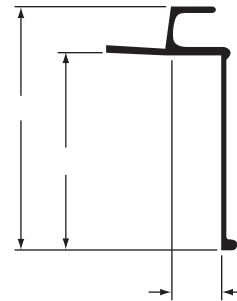

**5" NOSE RAIL, R-PLATE, 102"**  
Stoughton Number  
**WAB-04A01826**

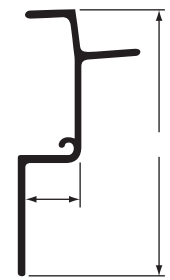

**5" NOSE RAIL, ALUM, 102"**  
Stoughton Number  
**WAB-04A02464**

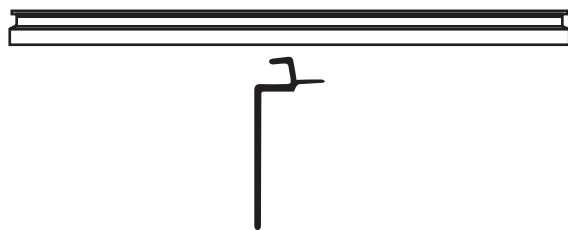

**NOSE RAIL, LOWER, UNPUNCHED, 102"**  
Stoughton Number  
**WAB-04A02474**

**NOSE RAIL, LOWER, UNPUNCHED, 102"**  
Stoughton Number  
**WAB-04A02521**

**FRONT WALL COVERS**

Stoughton

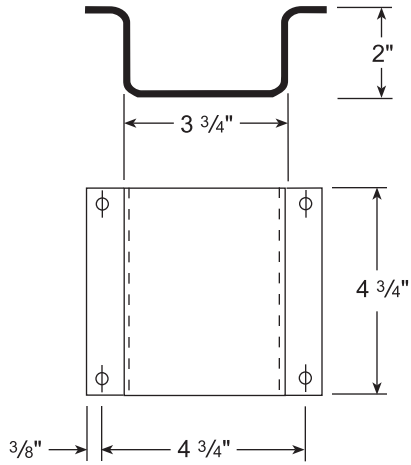

**AIRLINE COVER, FRONT WALL**

Stoughton Number
01 12993 000 00

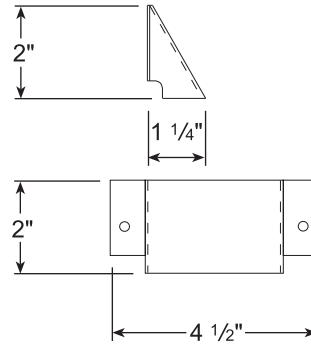

**WIRE COVER, FRONT WALL**

Stoughton Number
01 11610 000 00



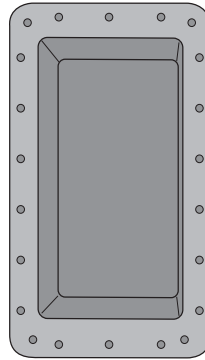

### RECESS PANS

Stoughton Number	Depth	Cutout Size	Overall Size	Material
01 15792 000 00	1 3/16"	13" x 21"	15" x 23"	Aluminum
P-80-197-8	2 1/4"	11 3/4" x 17 3/4"	15" x 21"	Aluminum

See page 14-9 for more options

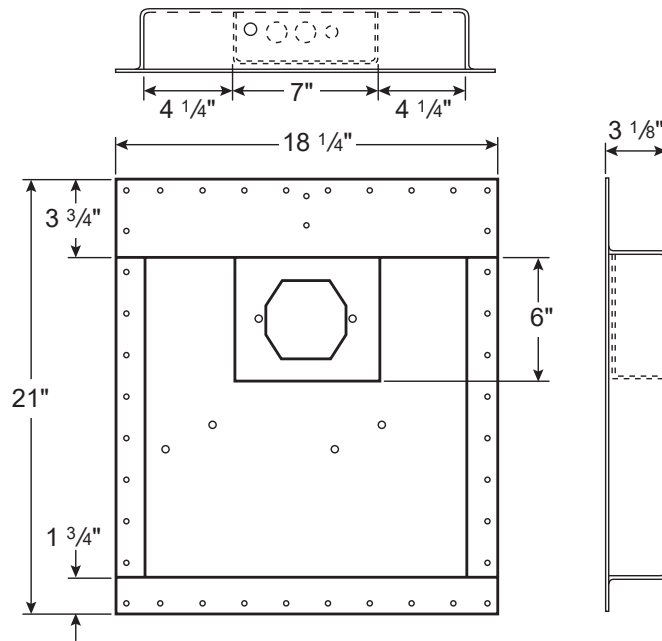

### NOSE BOX PAN

Stoughton Number	Remarks
20 03640 000 00	UPS 28' Only

