

Flooring Boards – Wood.....	6-1
Stoughton.....	6-1
Floor Screws.....	6-1
Stoughton.....	6-1
Flooring Boards – Extruded Aluminum.....	6-2
Stoughton.....	6-2
Crossmembers.....	6-3
Stoughton.....	6-3
Strick.....	6-3
Trailmobile.....	6-4
Utility.....	6-4
Crossmember Assemblies.....	6-4
Stoughton.....	6-4
Crossmember Clips and Bolt Kits.....	6-5
Stoughton.....	6-5
Crossmember Endplates.....	6-5
Stoughton.....	6-5
Floor – Miscellaneous.....	6-6
Stoughton.....	6-6
Galvanized Steel Floor Rails.....	6-6
Floor Sealer Products.....	6-6

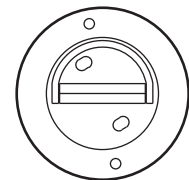

FLOORING BOARDS – WOOD

Stoughton

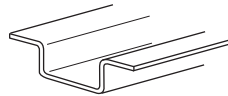
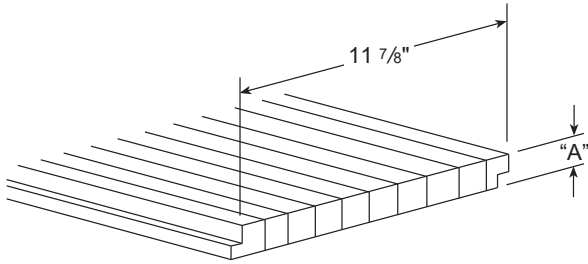

INTERMEDIATE FLOOR BOARD

Stoughton Number	Type	"A"	Length
04 92020 027 OK	Oak	1 3/8"	27' 2"
04 92020 240 XX*	Oak	1 3/8"	20'
04 92020 048 OK	Oak	1 3/8"	47' 2"
04 92020 053 OK	Oak	1 3/8"	52'
04 92021 027 OK	Oak	1 1/4"	27' 2"
04 92021 048 OK	Oak	1 1/4"	47' 2"
04 92021 053 OK	Oak	1 1/4"	52'
04 92022 027 OK	Oak	1 1/8"	27' 2"
04 92022 048 OK	Oak	1 1/8"	47' 2"
04 92022 053 OK	Oak	1 1/8"	52'

* 12.5" width

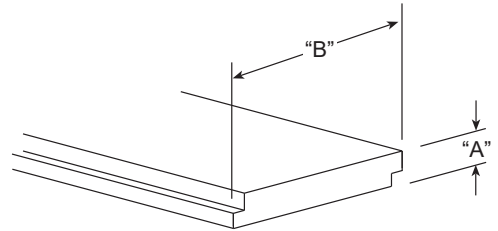

APITONG RANDOM LENGTH BOARDS

Stoughton Number	"A"	"B"
04 92015 000 00	1 5/16"	7"
04 92015 000 05	1 5/16"	5"
04 92080 000 00	1 1/8"	7"
04 92080 000 05	1 1/8"	5"

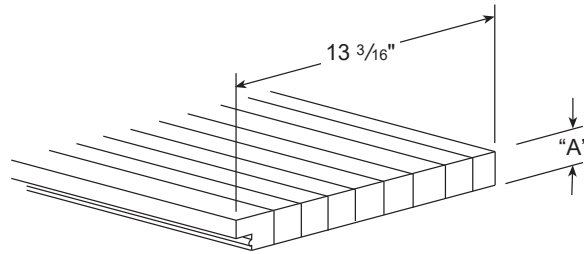

EDGE BOARD

Stoughton Number	Type	"A"	Length
04 92292 326 XX	Oak	1 3/8"	27' 2"

FLOOR SCREWS

Stoughton

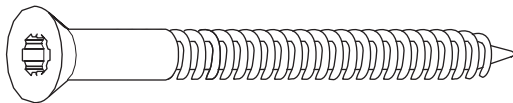

5/16" TORX FLATHEAD SCREW

Stoughton Number	Dimensions	Box Quantity
04 96501 200 00	5/16"-18 x 2"	Bulk
04 96501 200 T40	5/16"-18 x 3"	Bulk
04 96501 250 00	5/16"-18 x 2 1/2"	1000
04 96501 300 00	5/16"-18 x 3"	1000
04 96501 400 00	5/16"-18 x 3"	Bulk

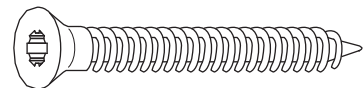

1/4" TORX FLATHEAD SCREW

Stoughton Number	Dimensions	Box Quantity
04 96507 150 XX	1/4"-20 x 1 1/2"	2000
04 96507 175 XX	1/4"-20 x 1 3/4"	2000
04 96507 200 XX	1/4"-20 x 2"	2200
04 96507 250 XX	1/4"-20 x 2 1/2"	1800
04 96507 300 XX	1/4"-20 x 3"	1200
04 96507 400 XX	1/4"-20 x 4"	1500
04 96507 500 XX	1/4"-20 x 5"	400

FLOORING BOARDS – EXTRUDED ALUMINUM

Stoughton

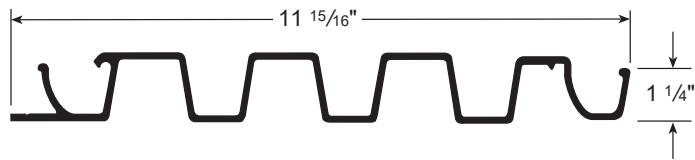

10" FLOOR BOARD

Extrusion Number	Length
AS8202	47'

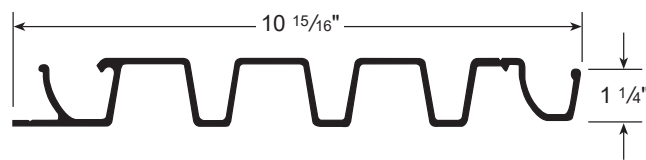

9" FLOOR BOARD

Extrusion Number	Length
AS8203	47'

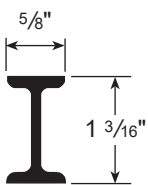

REEFER FLOOR INSERT

Extrusion Number	Length
02 05195 120 00	120"

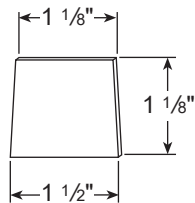

FLOOR END PLATE

Stoughton Number
01 06499 001 00

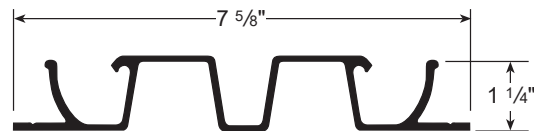

STARTER BOARD

Extrusion Number	Length
AS5782	47'

CROSSMEMBERS Stoughton

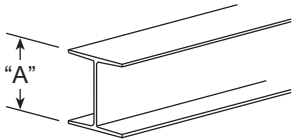
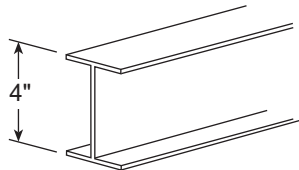

Stoughton Number	Length	Material
02 06654 100 25	100 1/4"	Aluminum
04 06638 102 00	102"	Steel – Primed*
04 06638 102 XX	102"	Steel – Unprimed*
04 06638 DRILL 00	102"	Primed w/ Air Line Holes
04 06638 DRILL XX	102"	Unprimed w/ Air Line Holes

Stoughton Number	Length	"A"	Material
04 07052 102 00	102"	3"	Steel
04 06638 102 X6	102"	6"	Steel

* 80,000 Yield

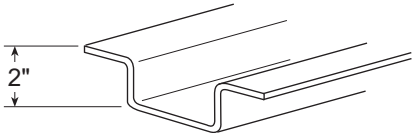

2" HAT

Stoughton Number	Length	Material	"A"	Remarks
03 07882 004 00	100 9/16"	Steel	2"	55 lbs

See page 6-5 for Crossmember End Plates

Strick

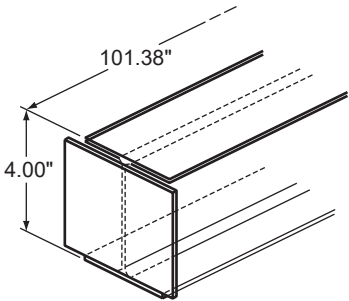

CROSSMEMBER, 4" x 101.38"

Stoughton Number
STR#01695
STRAA61F03510100

CROSSMEMBERS

Trailmobile

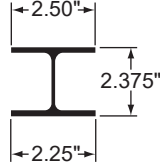

CROSSMEMBER, 2.375" x 101.28"

Stoughton Number
TM6001-3-123B

Utility

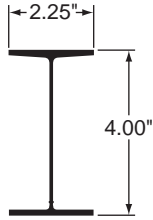

4" CROSSMEMBER, I-BEAM, 101.75"

Stoughton Number
UT-04-2575-0-099

Picture
Not
Available

DOOR GASKET, 168"

Stoughton Number
UT-04-2575-0-118

CROSSMEMBER ASSEMBLIES

Stoughton

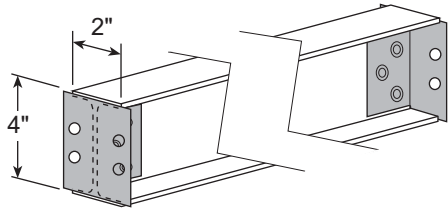

4" CROSSMEMBER ASSEMBLY

Stoughton Number	Length	Material
17 03389 001 00	101 1/8"	Aluminum

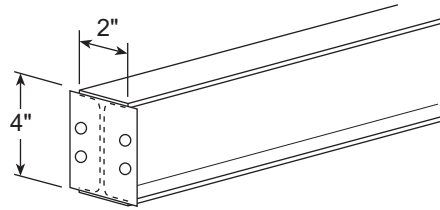

4" CROSSMEMBER ASSEMBLY

Stoughton Number	Length	Material	Remarks
04 18454 001 00	101 1/8"	Steel	3.19 lbs/ft
17 06637 000 00	99 5/8"	Steel	3.19 lbs/ft

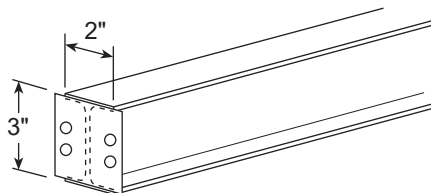

3" CROSSMEMBER ASSEMBLY

Stoughton Number	Length	Material
04 20018 001 00	101 1/8"	Steel

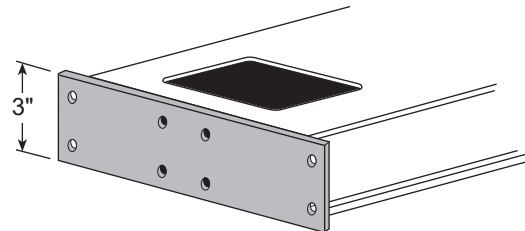

REAR CROSSMEMBER AT TUNNEL
CONTAINER ONLY

Call with container VIN (Serial Number)
for correct application

CROSSMEMBER CLIPS AND BOLT KITS

Stoughton

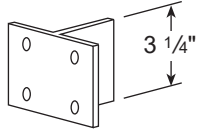

ALUMINUM

Stoughton Number
01 04921 000 00

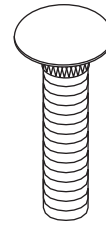

Kit contains eight (8) of each piece

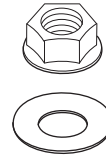

CROSSMEMBER BOLT KIT

Stoughton Number	Remarks
04 06638 KIT	100 per Carton

CROSSMEMBER ENDPLATES

Stoughton

For 4" I Beam

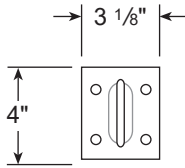

Stoughton Number
NDSC-1

Optional aftermarket

For 4" I Beam

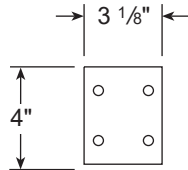

Stoughton Number
01 07224 001 00

OE style

For 3" I Beam

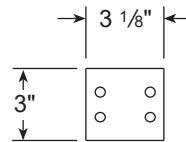

Stoughton Number
01 07224 002 00

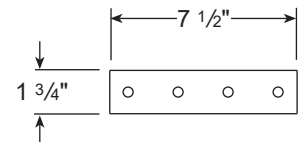

Stoughton Number
01 07884 000 00

For 2" Hat

FLOOR – MISCELLANEOUS

Stoughton

"Floor Flashing"

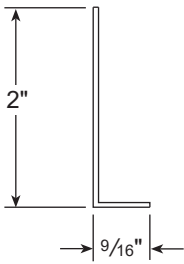

GALVANIZED STEEL FLOOR ANGLE

Stoughton Number
03 04604 144 00

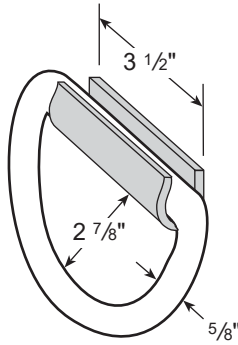

"D" RING ASSEMBLY

Stoughton Number
FE982-00046

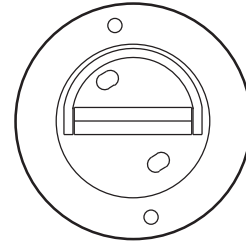

TIE RING

Stoughton Number
FE983-00135

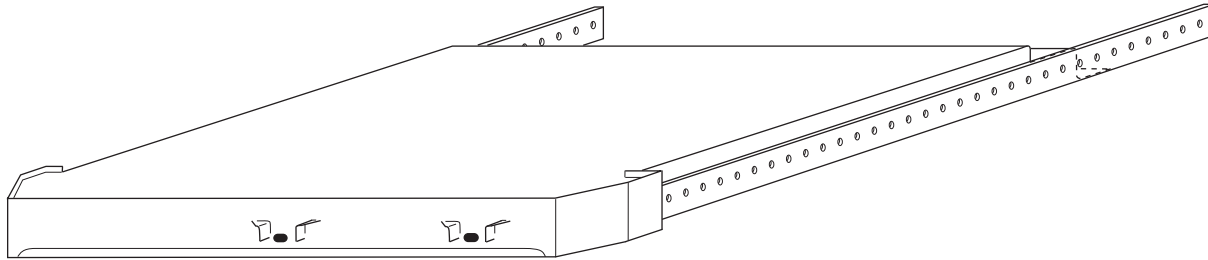

UPPER COUPLER ASSEMBLY

Call with trailer VIN (Serial Number) for correct application

For King Pins, see page 14-1

Galvanized Steel Floor Rails

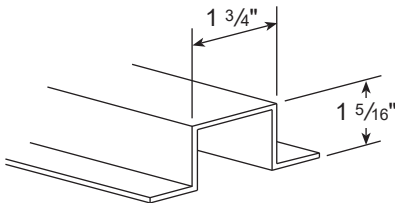

Stoughton Number	Length
03 85008 577 25	577 1/4"

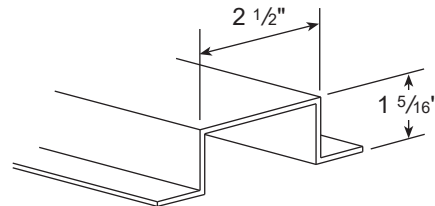

Stoughton Number	Length
03 85009 577 25	577 1/4"

Floor Sealer Products



Stoughton Number	Description
KPEC-53A/BSFK	Floor Sealer – Clear – Solvent Free – For 53' Trailer and Longer
KPEC-1055A/BSFK	Floor Sealer – Clear – Solvent Free – For 48' Trailer and Shorter
KPPF100A/B	Crack Filler
KPQP300-QT	Quick Patch – Quart
KPSQUEEGEE-18	18" Squeegee

Other Key Polymer products available. Call with your needs.