

Fasteners.....	8-1
Stoughton.....	8-1
Rivets – Standard Brazier Head Aluminum	8-2
Stoughton.....	8-2
Rivets – Standard Universal Head Aluminum.....	8-3
Stoughton.....	8-3
Rivets 8-4	
Stoughton.....	8-4
Floor Screws.....	8-5
Stoughton.....	8-5
FRP Fasteners	8-5
Stoughton.....	8-5
Miscellaneous Fasteners.....	8-6
Stoughton.....	8-6

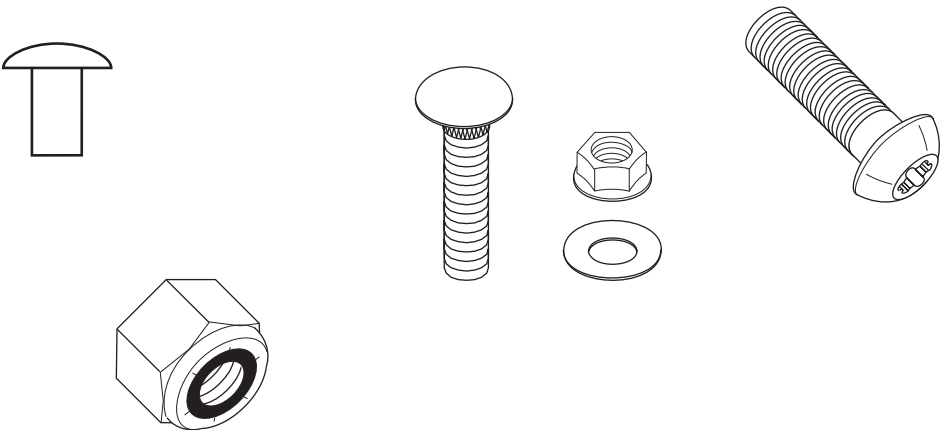

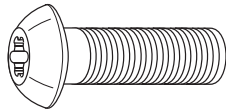

**BUTTON HEAD TORX CAPSCREW
TORX® PLUS**

Stoughton Number	Dimensions	Remarks
04 95033 100 00	3/8"-24 x 1"	TX 45
04 95033 125 00	3/8"-24 x 1 1/4"	TP 10016
04 95033 150 00	3/8"-24 x 1 1/2"	TX 45

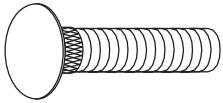

ROOF BOW BOLT

Stoughton Number	Dimensions	Remarks
04 95029 100 00	5/16"-18 x 1"	Standard
04 95075 100 00	1/4"-20 x 1"	Z-Plate

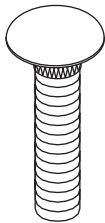

Kit contains eight (8) of each piece

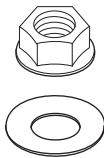

CROSSMEMBER BOLT KIT

Stoughton Number
04 06638 KIT

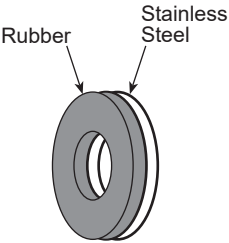

**ROOF BOW
RUBBER/STEEL
WASHER - 5/16"**

Stoughton Number	Remarks
04 96031 000 00	Standard
04 96042 000 00	Z-Plate

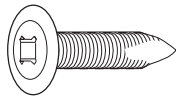

**PLYWOOD LINER SCREW SQUARE
DRIVE**

Stoughton Number	Dimensions
04 85592 075 00	3/16"-20 x 3/4"
04 85592 100 00	3/16"-20 x 1"

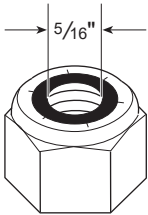

ROOF BOW HEX NUT - 5/16"

Stoughton Number	Description	Remarks
04 95536 000 00	Stainless Steel	Standard
04 95549 000 00	Stainless Steel	Z-Plate

RIVETS – STANDARD BRAZIER HEAD ALUMINUM

Stoughton

See page 8-4 for part numbers

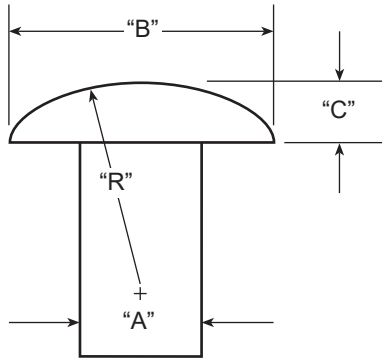

Dimensions

A	B	C	R
1/16"	0.156	0.031	0.114
3/32"	0.235	0.047	0.171
1/8"	0.312	0.062	0.227
5/32"	0.390	0.078	0.283
3/16"	0.467	0.094	0.339
1/4"	0.625	0.125	0.454
5/16"	0.780	0.156	0.566
3/8"	0.937	0.187	0.680

Alloys

1100F
2117T4 (Dimple)
6061T6
6053T61
5056H32

Approximate Pieces in a Pound

Length (Inches)	Nominal Diameter (Inches)														
	1/16 0.062	3/32 0.094	1/8 0.125	5/32 0.156	3/16 0.187	7/32 0.219	1/4 0.250	9/32 0.281	5/16 0.312	3/8 0.375	7/16 0.437	1/2 0.500	9/16 0.562	5/8 0.625	3/4 0.750
1/16	19,833	6,587	3,012	•••	•••	•••	•••	•••	•••	•••	•••	•••	•••	•••	•••
3/32	16,644	5,761	2,698	1,479	887	•••	•••	•••	•••	•••	•••	•••	•••	•••	•••
1/8	14,337	5,120	2,443	1,357	823	•••	•••	•••	•••	•••	•••	•••	•••	•••	•••
3/16	11,225	4,187	2,055	1,166	720	481	337	•••	•••	•••	•••	•••	•••	•••	•••
1/4	9,223	3,542	1,773	1,022	640	432	305	224	169	103	•••	•••	•••	•••	•••
5/16	7,827	3,069	1,559	910	576	392	279	206	156	97	64	45	•••	•••	•••
3/8	6,798	2,708	1,391	820	523	358	257	191	145	90	60	42	31	23	•••
7/16	6,009	2,422	1,256	748	480	330	238	177	136	85	57	40	29	22	•••
1/2	5,383	2,191	1,145	684	443	306	222	166	127	80	54	38	28	21	13
9/16	4,876	2,000	1,052	632	411	286	207	155	120	76	51	36	27	20	13
5/8	4,456	1,840	973	587	384	268	195	147	113	72	49	35	26	20	12
11/16	4,102	1,704	905	548	360	252	184	139	108	69	47	33	25	19	12
3/4	3,800	1,586	845	514	338	237	174	132	102	66	45	32	24	18	11
7/8	3,314	1,394	748	457	303	213	157	119	93	60	41	30	22	17	11
1	2,937	1,243	670	412	274	194	143	109	85	56	38	28	21	16	10
1 1/8	2,638	1,112	607	375	250	178	131	100	79	52	36	26	19	15	9.5
1 1/4	2,393	1,022	555	343	230	164	122	93	73	48	33	24	18	14	9.0
1 3/8	•••	939	511	317	213	152	113	87	68	45	31	23	17	13	8.6
1 1/2	•••	868	474	295	198	142	106	81	64	42	30	22	16	13	8.2
1 3/4	•••	754	413	258	174	125	93	72	57	38	27	20	15	12	7.5
2	•••	666	366	229	155	112	84	65	51	34	24	18	14	11	6.9
2 1/4	•••	•••	329	206	140	101	76	59	47	31	22	16	13	9.9	6.4
2 1/2	•••	•••	299	188	128	92	69	54	43	29	20	15	12	9.2	6.0
2 3/4	•••	•••	273	172	117	85	64	50	40	27	19	14	11	8.6	5.6
3	•••	•••	252	159	108	78	59	46	37	25	18	13	10	8.0	5.3
3 1/4	•••	•••	•••	148	100	73	55	43	34	23	17	12	9.6	7.6	5.0
3 1/2	•••	•••	•••	138	94	68	52	40	32	22	16	12	9.0	7.1	4.7
3 3/4	•••	•••	•••	129	88	64	49	38	30	21	15	11	8.5	6.8	4.5
4	•••	•••	•••	122	83	60	46	36	29	19	14	10	8.1	6.4	4.0
4 1/4	•••	•••	•••	•••	79	57	43	34	27	18	13	10	7.7	6.1	4.1
4 1/2	•••	•••	•••	•••	75	54	41	32	26	18	13	9.5	7.4	5.9	3.9
4 3/4	•••	•••	•••	•••	71	52	39	31	25	17	12.4	9.1	7.0	5.6	3.7
5	•••	•••	•••	•••	68	49	37	29	23	16	11.8	8.7	6.6	5.4	3.6
5 1/4	•••	•••	•••	•••	•••	47	36	28	22	15	11.3	8.3	6.2	5.2	3.5
5 1/2	•••	•••	•••	•••	•••	•••	34	27	22	15	10.9	8.0	5.9	5.0	3.3



RIVETS – STANDARD UNIVERSAL HEAD ALUMINUM

Stoughton

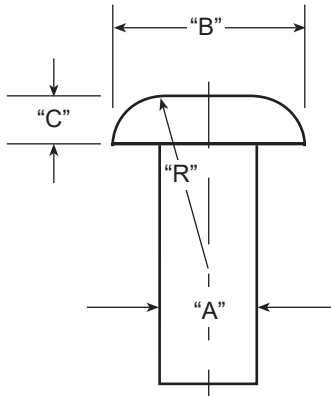

See page 8-4 for part numbers

Dimensions

A	B	C	R
1/16"	0.125	0.032	0.054
3/32"	0.187	0.045	0.082
1/8"	0.250	0.059	0.108
5/32"	0.312	0.072	0.135
3/16"	0.375	0.085	0.164
1/4"	0.500	0.112	0.217
5/16"	0.625	0.138	0.272
3/8"	0.750	0.166	0.328

Alloys

1100F
2117T4 (Dimple)
6061T6
6053T61
5056H32

Approximate Pieces in a Pound

Length (Inches)	Nominal Diameter (Inches)							
	1/16 0.062	3/32 0.094	1/8 0.125	5/32 0.156	3/16 0.187	1/4 0.250	5/16 0.312	3/8 0.375
1/16	24,390	8,457	3,968	•••••	•••••	•••••	•••••	•••••
3/32	19,608	7,194	3,436	1,908	1,261	•••••	•••••	•••••
1/8	16,667	6,250	3,040	1,712	1,136	•••••	•••••	•••••
3/16	12,658	4,926	2,457	1,418	952	427	•••••	•••••
1/4	10,204	4,049	2,066	1,212	813	377	214	149
5/16	8,547	3,436	1,783	1,057	714	338	193	135
3/8	7,353	2,994	1,565	935	633	306	177	123
7/16	6,452	2,646	1,397	840	571	279	163	114
1/2	5,747	2,375	1,261	763	521	257	151	105
9/16	5,181	2,151	1,148	699	476	238	141	98
5/8	4,717	1,969	1,055	645	441	222	132	92
11/16	4,329	1,811	971	599	408	207	124	86
3/4	4,000	1,681	909	559	382	195	117	81
7/8	3,472	1,466	794	493	337	174	105	73
1	3,067	1,300	709	441	301	157	95	66
1 1/8	2,488	1,168	637	398	273	143	87	61
1 1/4	2,092	1,059	581	364	249	132	81	56
1 3/8	•••••	971	535	334	229	122	75	52
1 1/2	•••••	893	493	310	212	113	69	49
1 3/4	•••••	775	427	270	185	99	61	43
2	•••••	680	377	238	163	88	55	38
2 1/4	•••••	•••••	338	214	147	80	50	34
2 1/2	•••••	•••••	306	194	133	73	45	31
2 3/4	•••••	•••••	279	177	122	67	41	29
3	•••••	•••••	257	163	112	62	38	27
3 1/4	•••••	•••••	•••••	151	104	57	36	25
3 1/2	•••••	•••••	•••••	141	97	53	33	23
3 3/4	•••••	•••••	•••••	132	91	50	31	22
4	•••••	•••••	•••••	124	85	47	30	21
4 1/4	•••••	•••••	•••••	•••••	81	45	28	20
4 1/2	•••••	•••••	•••••	•••••	76	42	27	19
4 3/4	•••••	•••••	•••••	•••••	72	40	25	18
5	•••••	•••••	•••••	•••••	69	38	24	17
5 1/4	•••••	•••••	•••••	•••••	•••••	36	23	16
5 1/2	•••••	•••••	•••••	•••••	•••••	35	22	15

RIVETS

Stoughton

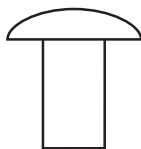

3/16" DIAMETER BRAZIER HEAD RIVETS

Stoughton Number	Description
04 98002 313 XX	3/16" x 5/16" Aluminum
04 98002 375 XX	3/16" x 3/8" Aluminum
04 98002 438 XX	3/16" x 7/16" Aluminum
04 98002 500 XX	3/16" x 1/2" Aluminum
04 98002 563 XX	3/16" x 9/16" Aluminum
04 98002 625 XX	3/16" x 5/8" Aluminum
04 98002 750 XX	3/16" x 3/4" Aluminum

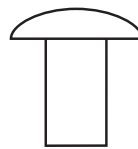

1/4" DIAMETER BRAZIER HEAD RIVETS

Stoughton Number	Description
04 98003 100 XX	1/4" x 1" Aluminum
04 98003 438 XX	1/4" x 7/16" Aluminum
04 98003 500 XX	1/4" x 1/2" Aluminum
04 98003 563 XX	1/4" x 9/16" Aluminum
04 98003 625 XX	1/4" x 5/8" Aluminum
04 98003 688 XX	1/4" x 11/16" Aluminum
04 98003 750 XX	1/4" x 3/4" Aluminum
04 98003 875 XX	1/4" x 7/8" Aluminum



3/8" STANDARD UNIVERSAL HEAD RIVETS

Stoughton Number	Description
04 98038 100 XX	3/8" x 1" Aluminum
04 98038 813 XX	3/8" x 13/16" Aluminum
04 98038 875 XX	3/8" x 7/8" Aluminum



3/16" DIAMETER STANDARD UNIVERSAL HEAD RIVETS

Stoughton Number	Description
04 98039 375 XX	3/16" x 3/8" Aluminum
04 98039 438 XX	3/16" x 7/16" Aluminum
04 98039 500 XX	3/16" x 1/2" Aluminum
04 98039 563 XX	3/16" x 9/16" Aluminum

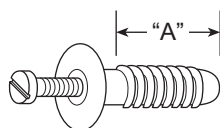

TAPITS

Stoughton Number	Description	"A"
04 98010 000 00	1/4" Nylon Tap-it	3/4"
04 98010 000 01	1/4" Nylon Tap-it	1"

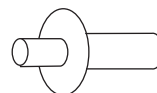

DRIVE RIVETS

Stoughton Number	Diameter	Grip Range
04 98054	3/16"	.265-.359

XX = 2117-T3 Alloy (Hard)
 X1 - H1100 Alloy (Soft)
 02 = 2117-T3 Alloy (Hard) "Powder Coated Black"

Note: Buck rivets sold "per pound"

FLOOR SCREWS

Stoughton

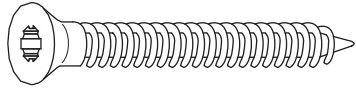

1/4" TORX FLATHEAD SCREW

Stoughton Number	Dimensions	Box Quantity
04 96507 150 XX	1/4"-20 x 1 1/2"	3000
04 96507 175 XX	1/4"-20 x 1 3/4"	2000
04 96507 200 XX	1/4"-20 x 2"	2200
04 96507 250 XX	1/4"-20 x 2 1/2"	1800
04 96507 300 XX	1/4"-20 x 3"	
04 96507 400 XX	1/4"-20 x 4"	1500
04 96507 500 XX	1/4"-20 x 5"	400

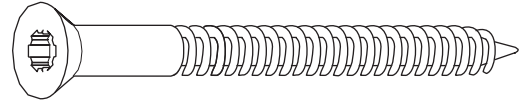

5/16" TORX FLATHEAD SCREW
TORX® PLUS

Stoughton Number	Dimensions	Box Quantity
04 96501 200 00	5/16"-18 x 2"	Bulk
04 96501 200 T40	5/16"-18 x 2"	
04 96501 250 00	5/16"-18 x 2 1/2"	1000
04 96501 300 00	5/16"-18 x 3"	1000
04 96501 350 00	5/16"-18 x 3 1/2"	1200
04 96501 400 00	5/16"-18 x 4"	
04 96501 500 00	5/16"-18 x 5"	300

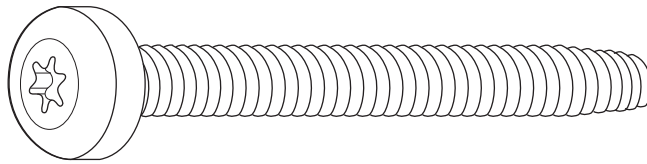

FLOOR SCREW ZIP

Stoughton Number	Description
04 96517 100 XX	5/16"-18 x 1" Pan Head/Torx Drive
04 96517 200 XX	5/16"-18 x 2" Pan Head/Torx Drive
04 96517 300 XX	5/16"-18 x 3" Pan Head/Torx Drive

FRP FASTENERS

Stoughton

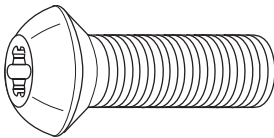

3/8" TORX CORROFLO

Stoughton Number	Dimensions
04 97508 100 00	3/8"-16 x 1"

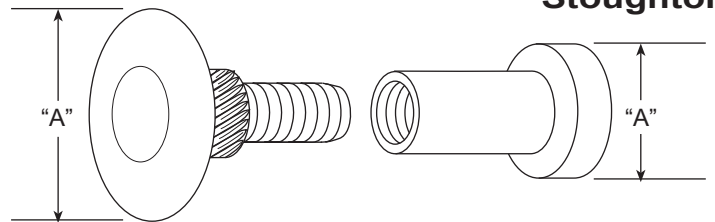

CAMTAINER

Stoughton Number	Description	"A"
04 97511 000 00	Bolt Camtainer – 880-82920	.893
04 97505 000 03	Nut Camtainer (Torx) – 890-60020	.618
04 97507 000 00	Nut Camtainer (Torx) – 890-60008	1.000

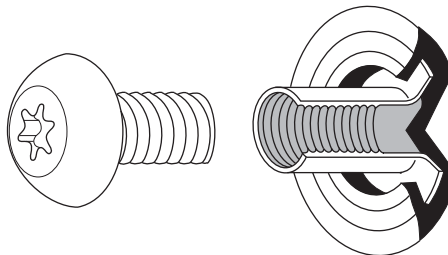

POLY SEAL

Stoughton Number	Description
04 95028 075 00	5/16"-18 x 3/4" Torx Truss Head
04 95028 100 00	5/16"-18 x 1" Torx Truss Head
04 97611 000 00	5/16"-18 x 1/2" FRP Panel Nut
04 98505 000 00	5/16" Poly Seal T-Nut

Other items may be available.
Call with your needs.

MISCELLANEOUS FASTENERS

Stoughton

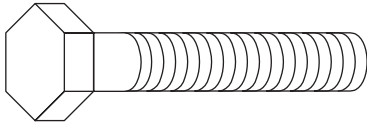

HEX HEAD CAP SCREW

Stoughton Number	Dimensions
04 95003 100 00	3/8"-16 x 1"

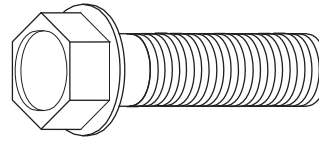

WASHER HEAD CAP SCREW

Stoughton Number	Dimensions
04 95007 125 00	3/8"-24 x 1 1/4"

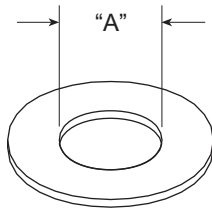

FLAT WASHER

Stoughton Number	"A"
04 96004	5/16"
04 96006	3/8"
04 96008	1/2"

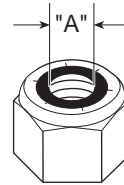

NYLON LOCK NUT

Stoughton Number	"A"
04 95501 000 00	1/4"-20
04 95502 000 00	5/16"-18
04 95503 000 00	3/8"-16
04 95504 000 00	3/8"-24
04 95506 000 00	5/8"-11